

Load**LIFTER** 5000™ **ULTIMATE**

ADJUSTABLE AIR HELPER SPRINGS

TOW AND HAUL WITH SAFETY AND COMFORT™



Kit Number
88228

INSTALLATION GUIDE

For maximum effectiveness and safety, please read these instructions completely before proceeding with installation.

Failure to read these instructions can result in an incorrect installation.

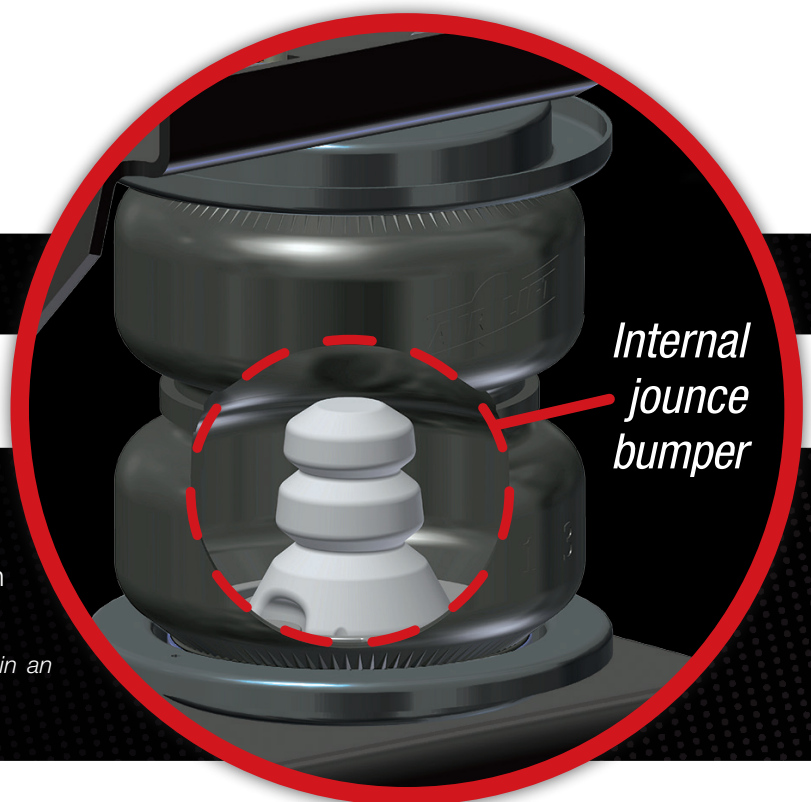

TABLE OF CONTENTS

Installation Diagrams	2-3
Hardware and Tools Lists	3
Introduction	4
Important Safety Notice	4
Notation Explanation	4
Installing the LoadLifter 5000 Ultimate System	5
Getting Started	5
Bellows and Bracket Assembly	6
Attaching the Assemblies to the Frame	7
Lower Bracket Installation (2004-2008 Models)	7
Lower Bracket Installation (2009 & Up Models)	9
Lower Bracket to Bellows Installation	12
Finishing the Installation	12
Installing the Heat Shield	13
Installing the Air Lines	14
Tips for installing Air Lines	15
Finished Installation (2004-08 Models)	17
Finished Installation (2009 & Up Models)	18
Before Operating	18
Checking for Leaks	18
Fixing Leaks	18
Installation Checklist	19
Post-Installation Checklist	19
Product Use, Maintenance and Servicing	20
Minimum and Maximum Pressure	20
Maintenance Guidelines	20
Tuning the Air Pressure	21
Guidelines for Adding Air	21
Troubleshooting Guide	22
Frequently Asked Questions	22
Limited Warranty and Return Policy	24
Replacement Information	25
Contact Information	25

Installation Diagram

Left side
(driver's side)

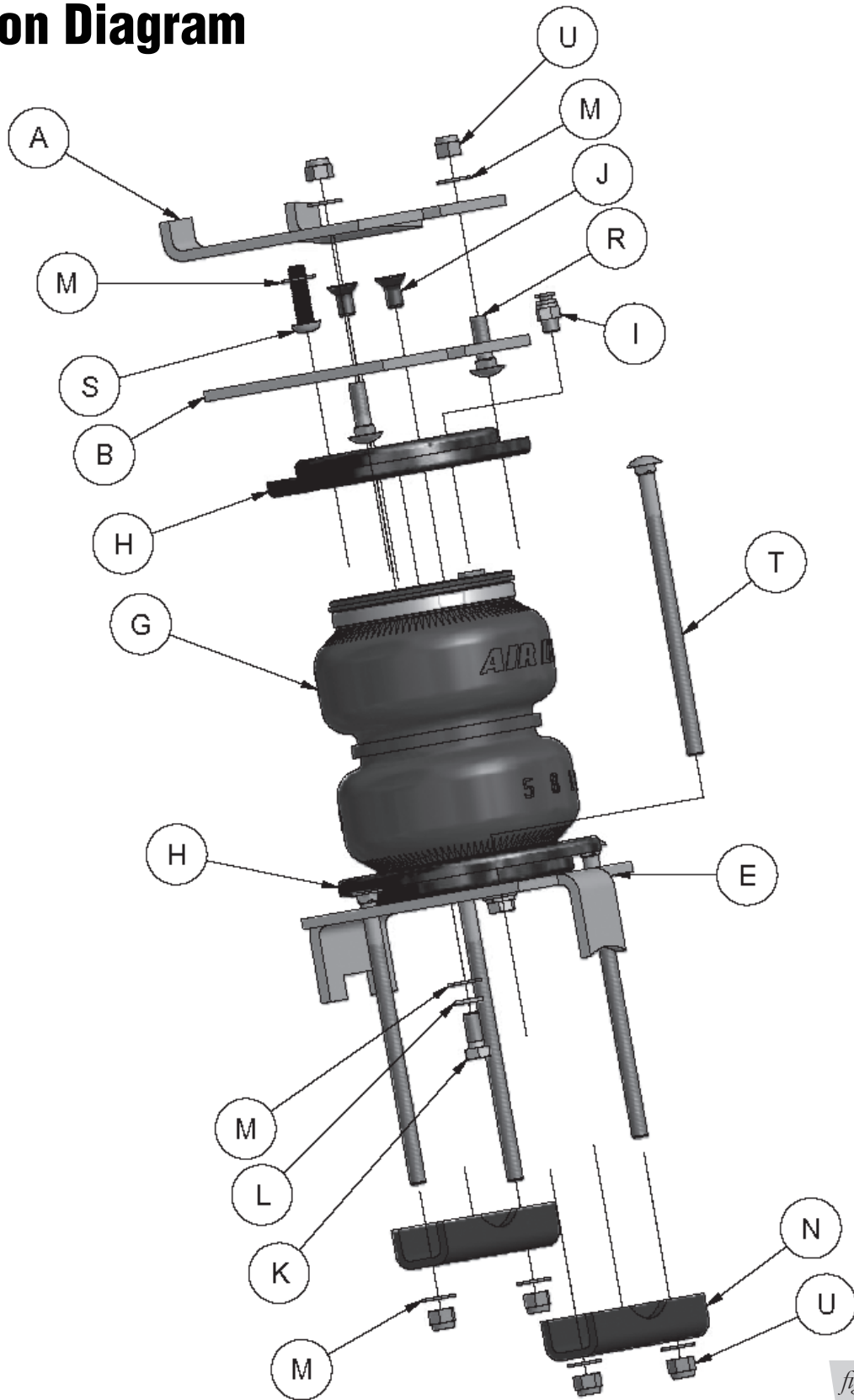
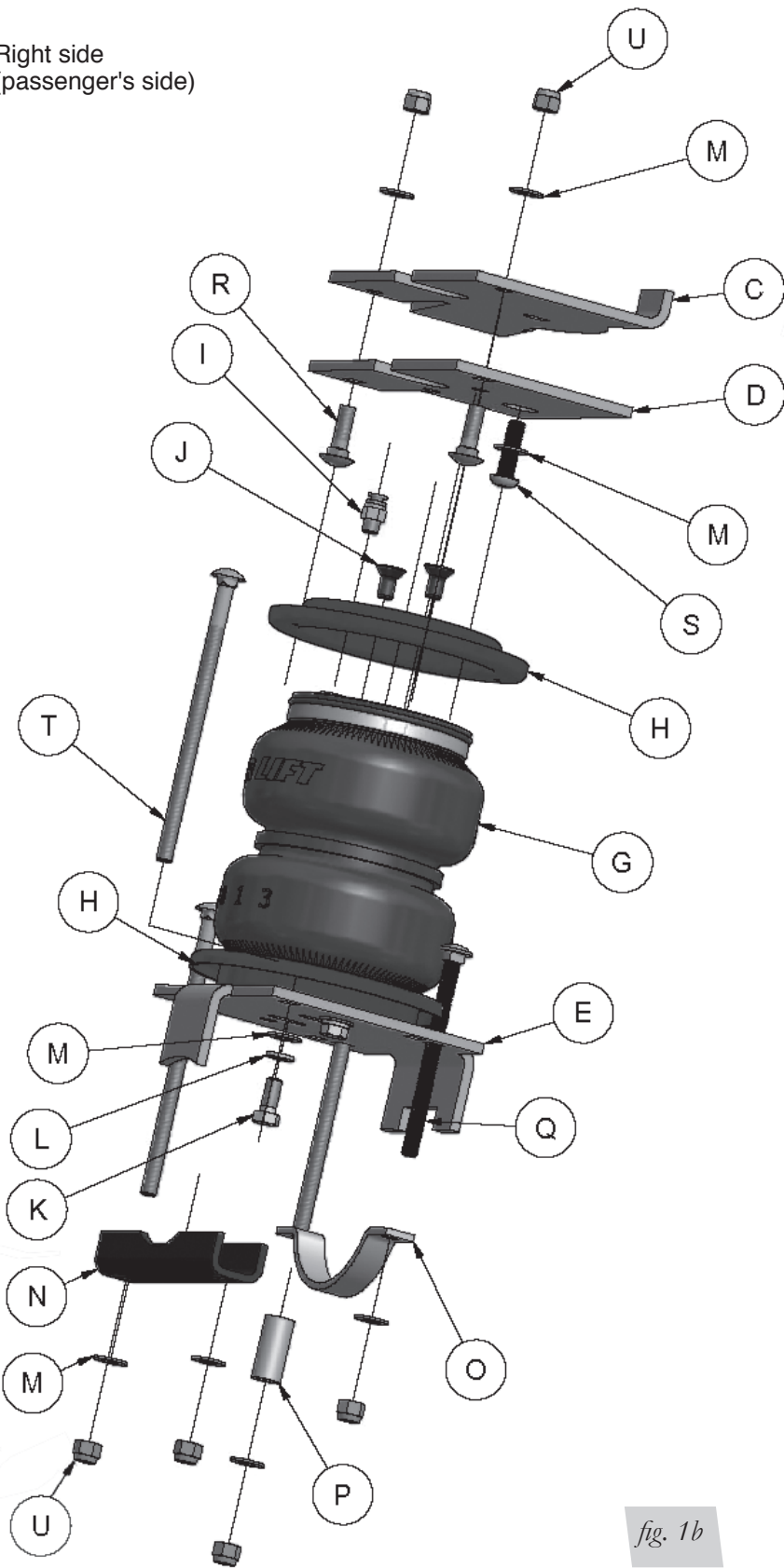

fig. 1a

Right side
(passenger's side)



HARDWARE LIST

Item	Part#	Description.....	Qty
A	07079	LH Upper Frame Bracket.....	1
B	07089	LH Upper Spring Bracket.....	1
C	07078	RH Upper Frame Bracket.....	1
D	07088	RH Upper Spring Bracket.....	1
E	03889	Lower Bracket.....	2
G	58496	Bellows	2
H	11967	Roll Plate	4
I	21839	Fitting.....	2
J	17215	3/8"-24 X 3/4" Flat Head Screw.....	4
K	17203	3/8"-24 X 7/8" Hex Head Bolt	4
L	18427	3/8" Lock Washer	4
M	18444	3/8" Flat Washer.....	20
N	01531	Clamp Bar.....	3
O	10451	Axle Strap.....	1
P	10673	Sleeve Spacer.....	1
Q	17168	3/8"-16 X 5" Carriage Bolt	1
R	17361	3/8"-16 X 1.25" Carriage Bolt.....	4
S	17366	M10-1.5" X 35 Button Head Screw ..	2
T	17163	3/8"-16 X 7" Carriage Bolt	7
U	18435	3/8"-16 Nylon Lock Nut	13
V	18605	M10-1.5" Universal Nut	2
W	26333	Clamp.....	1
X	17107	3/8"-16 X 1" Hex Bolt	1
AA	20086	Air Line.....	1
BB	10466	Tie Strap.....	6
CC	21230	Valve Cap.....	2
DD	18501	5/16" Flat Washer	2
EE	21234	Rubber Washer.....	2
FF	18411	Star Washer	2
GG	21233	5/16" Hex Nut.....	4

TOOLS LIST

Description.....	Qty
Hoist or Floor Jacks.....	1
Safety Stands	2
Safety Glasses	1
Torque Wrench.....	1
Standard Open-end Combo Wrenches	1
Metric and Standard Sockets	1
#6 Metric Allen Wrench (socket if available).....	1
7/32" Allen Wrench (socket if available)	1
Flat Head Screwdriver	1
Hack Saw or Grinder	1
5/16" Drill Bit (very sharp).....	1
Heavy Duty Drill.....	1
Hose Cutter, Razor Blade or Sharp Knife.....	1
Air Compressor or Compressed Air Source	1
Spray Bottle with Dish Soap/Water Solution.....	1

fig. 1b



Missing or damaged parts? Call Air Lift customer service at (800) 248-0892 for a replacement part.

Introduction

The purpose of this publication is to assist with the installation, maintenance and troubleshooting of the LoadLifter 5000 Ultimate air spring kit. LoadLifter 5000 Ultimate utilizes sturdy, reinforced, commercial grade single or double, depending on the kit, convolute bellows. The bellows are manufactured like a tire with layers of rubber and cords that control growth. LoadLifter 5000 Ultimate kits are recommended for most 3/4- and 1-ton pickups and SUVs with leaf springs and provide up to 5,000 pounds of load leveling support with air adjustability from 5-100 PSI. The kits are used in motor home rear applications and various front applications where leaf springs are used.

It is important to read and understand the entire installation guide before beginning installation or performing any maintenance, service or repair. The information here includes a hardware list, tool list, step-by-step installation information, maintenance guidelines and operating tips.

Air Lift Company reserves the right to make changes and improvements to its products and publications at any time. For the latest version of this manual, contact Air Lift Company at **(800) 248-0892** or visit airliftcompany.com.

IMPORTANT SAFETY NOTICE

The installation of this kit does not alter the gross vehicle weight rating (GVWR) or payload of the vehicle. Check your vehicle's owner's manual and do not exceed the maximum load listed for your vehicle.

Gross vehicle weight rating: The maximum allowable weight of the fully loaded vehicle (including passengers and cargo). This number — along with other weight limits, as well as tire, rim size and inflation pressure data — is shown on the vehicle's Safety Compliance Certification Label.

Payload: The combined, maximum allowable weight of cargo and passengers that the truck is designed to carry. Payload is GVWR minus the base curb weight.

NOTATION EXPLANATION

Hazard notations appear in various locations in this publication. Information which is highlighted by one of these notations must be observed to help minimize risk of personal injury or possible improper installation which may render the vehicle unsafe. Notes are used to help emphasize areas of procedural importance and provide helpful suggestions. The following definitions explain the use of these notations as they appear throughout this guide.

**DANGER**

INDICATES IMMEDIATE HAZARDS WHICH WILL RESULT IN SEVERE PERSONAL INJURY OR DEATH.

**WARNING**

INDICATES HAZARDS OR UNSAFE PRACTICES WHICH COULD RESULT IN SEVERE PERSONAL INJURY OR DEATH.

**CAUTION**

INDICATES HAZARDS OR UNSAFE PRACTICES WHICH COULD RESULT IN DAMAGE TO THE MACHINE OR MINOR PERSONAL INJURY.

NOTE

Indicates a procedure, practice or hint which is important to highlight.

Installing the LoadLifter 5000 Ultimate System

GETTING STARTED

DANGER

COMPRESSED AIR CAN CAUSE INJURY AND DAMAGE TO THE VEHICLE AND PARTS IF IT IS NOT HANDLED PROPERLY. FOR YOUR SAFETY, DO NOT TRY TO INFLATE THE AIR SPRINGS UNTIL THEY HAVE BEEN PROPERLY SECURED TO THE VEHICLE.

1. Raise the vehicle and support the axle with jack stands, setting the jack stands as wide as possible on the axle (Fig. 2).

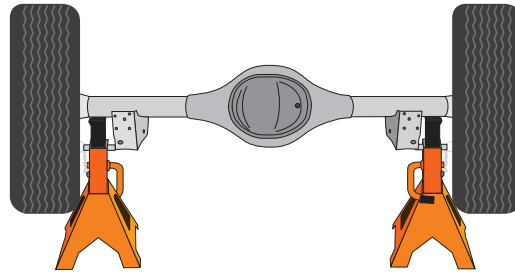
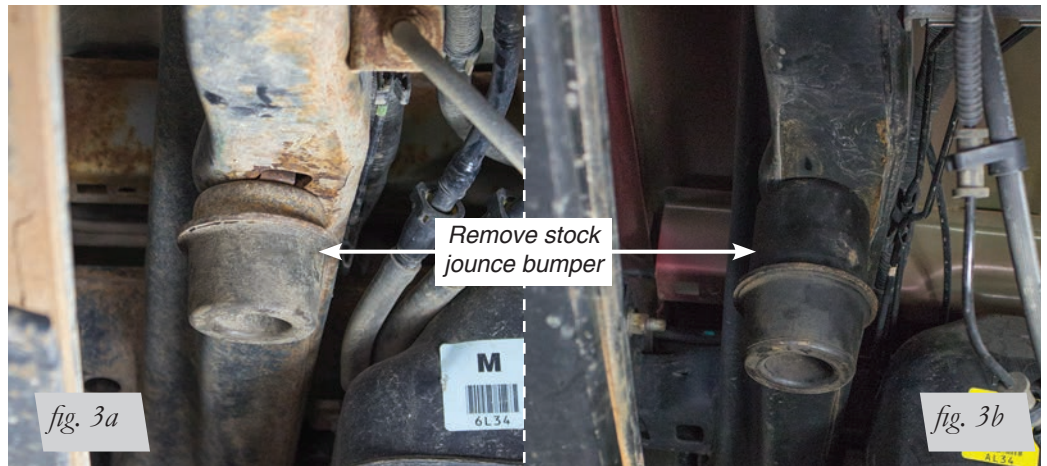

fig. 2

2. Drop the axle or raise the frame up to make room for the assemblies to be put into position between the frame and axle.
3. Remove both jounce bumpers between the frame and axle (Figs. 3a or 3b) and for early 04-08 models remove the stock Universal Nut that held the jounce bumpers in place (Fig. 4).



2004-2008 early model jounce bumper

2009 to current jounce bumper

Remove and discard the 04-08 Stock Universal Nut



4. For the early 04-08 models, install a new Universal Nut (V) into the large hole so that the threaded portion is up inside the frame (Fig. 5).

NOTE

No modifications are needed for the 2009 to current models.

Insert the 04-08 New Universal Nut (V) with the threaded portion inside the frame



5. All years: On the right side (passenger's side) there is an emergency brake cable holder that is bolted on to a bracket welded to the axle, with a self-taping bolt. In order to make clearance for the axle strap, it will be necessary to cut this off and/or grind this bolt flush to the bracket (Fig. 6).

Emergency brake cable holder

Early Model shown: The bolt must be cut off flush to the bracket.

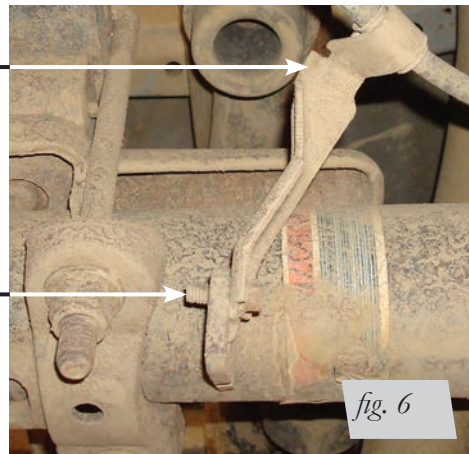

BELLOWS AND BRACKET ASSEMBLY

1. Set a roll plate (H) over the top of the bellows (G) (Fig. 1a-1b).

NOTE

The radiused (rounded) edge of the roll plate (G) will be towards the bellows so that the bellows is seated inside both roll plates.

2. Install the straight fitting (I) into the top of the bellows finger tight. Tighten the fitting one and a half turns.
3. Install the upper spring bracket (B & D) onto the bellows (G) using four (J) flat head screws (Fig. 1). Torque the upper spring bracket to no more than 20 lb.-ft. (27Nm)
4. These are right and left hand specific. The left assembly goes on the driver's side; the right assembly goes on the passenger's side (Fig. 7). Set aside for later use.

Left hand (driver's side) assembly

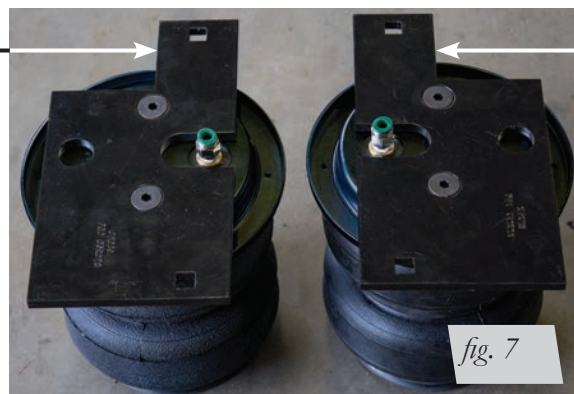

Right hand (passenger's side) assembly

ATTACHING THE ASSEMBLIES TO THE FRAME

1. With the new universal nut in the frame on the early model and no modification needed for the late model truck, attach the left frame mount bracket (A) onto the frame using a flat washer (M) and button head screw (S). Mount on the frame with the flange pointing up and as tight to the frame as you can get it while tightening the hardware (Figs. 8a & 8b). Torque to 38 lb.-ft. (52Nm). Repeat for the right side frame mount bracket (C).



LH (driver's side). Push bracket against frame and torque to 38 lb.-ft. (52Nm).

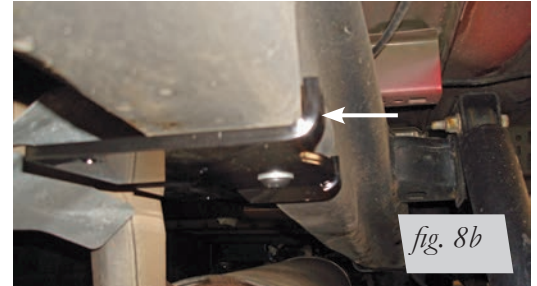

RH (passenger's side). Push bracket against frame and torque to 38 lb.-ft. (52Nm).

2. Attach the left and right hand assemblies to the frame brackets using carriage bolts (R), flat washers (M) and nylon lock nuts (U) (Figs. 9a & 9b). Torque to 31 lb.-ft. (42Nm).

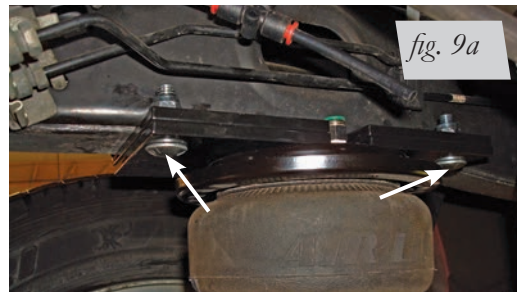

Left hand assembly (driver's side) attached with carriage bolts (R), flat washers (M) and nylon lock nuts (U). Torque to 31 lb.-ft. (42Nm).



Right hand assembly (passenger's side) attached with carriage bolts (R), flat washers (M) and nylon lock nuts (U). Torque to 31 lb.-ft. (42Nm).

LOWER BRACKET INSTALLATION (2004-2008 MODELS)

1. Set one of the lower brackets on the axle.

NOTE

The bracket must nest in between the stock U-bolts that hold the leaf spring to the axle (Fig. 10). Repeat for the other side.

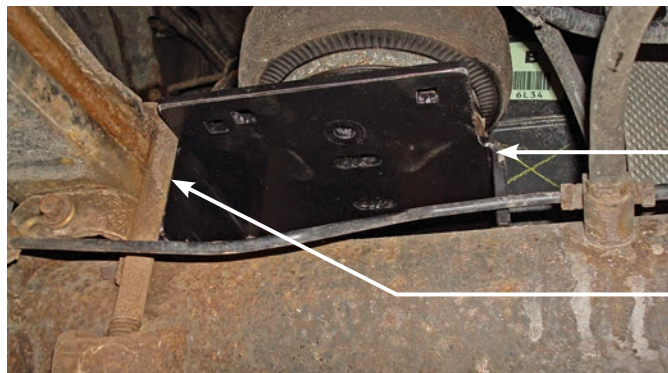

Push bracket against the leaf spring in between the U-bolts.

Set bracket into position on the axle.

2. Left side (driver's) installation: insert the long carriage bolts (T) into the bottom bracket.

NOTE

The inside square holes must be used for the carriage bolts (Fig. 11).

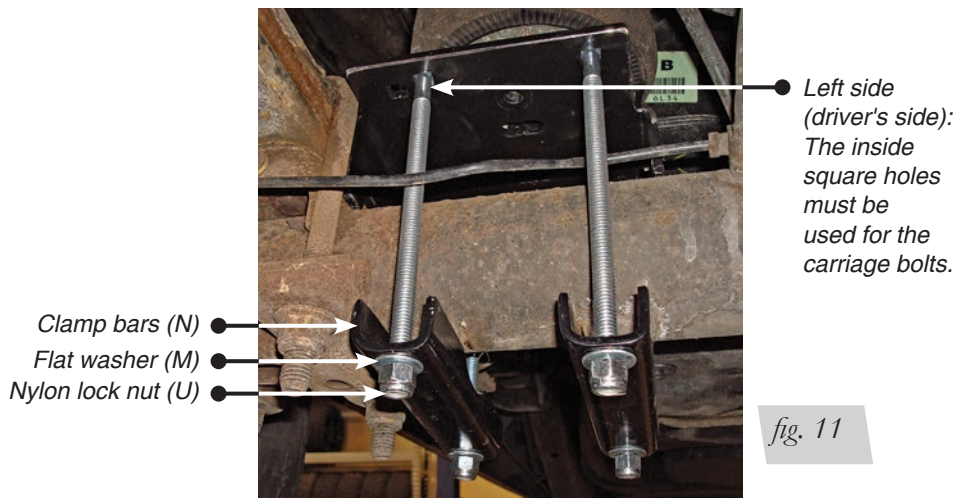

3. Install the lower clamp bars (N) over the carriage bolts installed previously and cap with flat washers (M) and nylon lock nuts (U) (Fig. 11). Torque the lower nuts evenly to 10 lb.-ft. (14Nm)

NOTE *Make sure the lower bracket stays against the leaf spring and in between the stock U-bolts (Fig. 10).*

4. Right side (passenger's) installation: insert two long carriage bolts (T) into the square holes on the furthest inside set of holes (Fig. 12). Set the axle strap (O) under the axle in between the emergency brake cable bracket and leaf spring retainer.

NOTE *The flange must be above the stock spring retainer, forward of the axle.*

Insert the last long carriage bolt (T) on the outside square holes, into the axle strap previously set into position. Cap with sleeve spacer (P), flat washer (M) and nylon lock nut (U).

5. On the backside of the axle, cap the axle strap previously installed with a flat washer (M) and nylon lock nut (U) (Fig. 13). Install the last lower clamp bar (N) over the two remaining carriage bolts and cap with flat washers (M) and nylon lock nuts (U). Torque the lower nuts evenly to 10 lb.-ft. (14Nm).

NOTE *It may be necessary to pry the carriage bolt over slightly with a screwdriver to gain access to the nylon nuts on the axle strap carriage bolts. Make sure the lower bracket stays against the leaf spring and in between the stock U-bolts during the tightening sequence.*

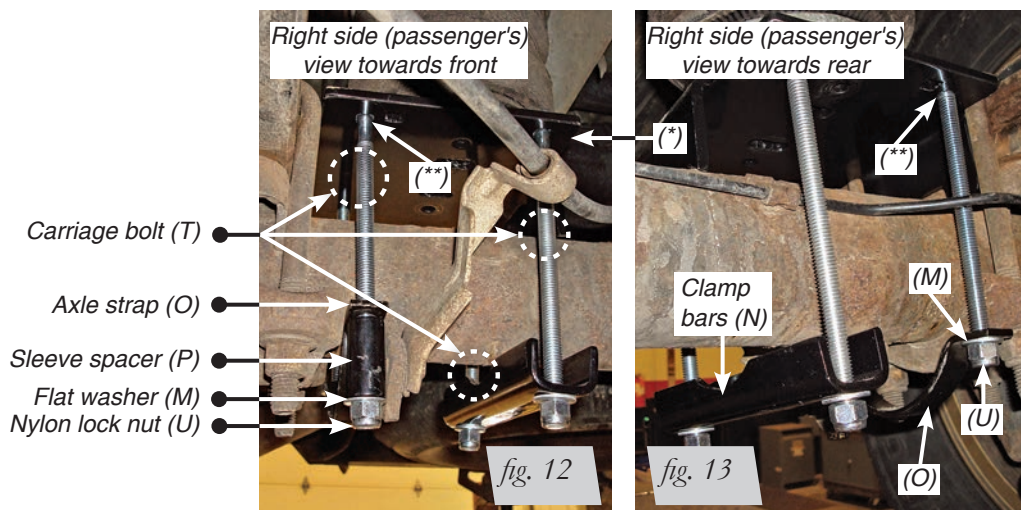

(*) Push the bracket against the leaf spring in between the stock U-bolts.

(**) Use outside set of square holes for carriage bolt (T).

LOWER BRACKET INSTALLATION (2009 & UP MODELS)

1. The later models have RSC (Roll Stability Control) bracket and brake lines on the left (driver's side) axle. This brake and ABS line will need to be positioned differently in order to make room for the lower bracket (Fig. 14).

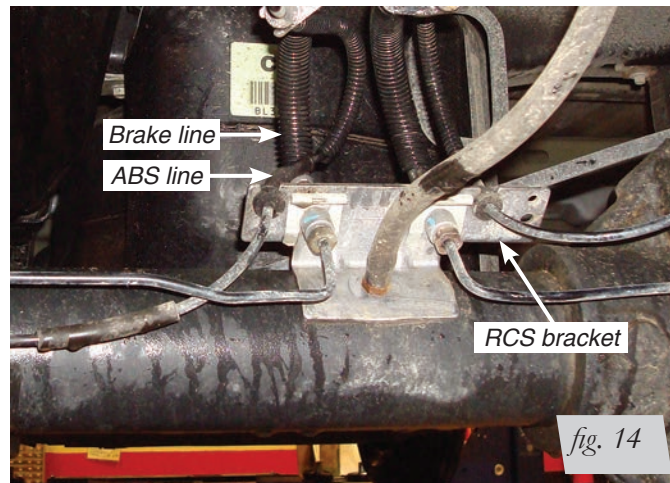

2. Remove the right ABS line out of the bracket by pulling it straight up (Fig. 15).

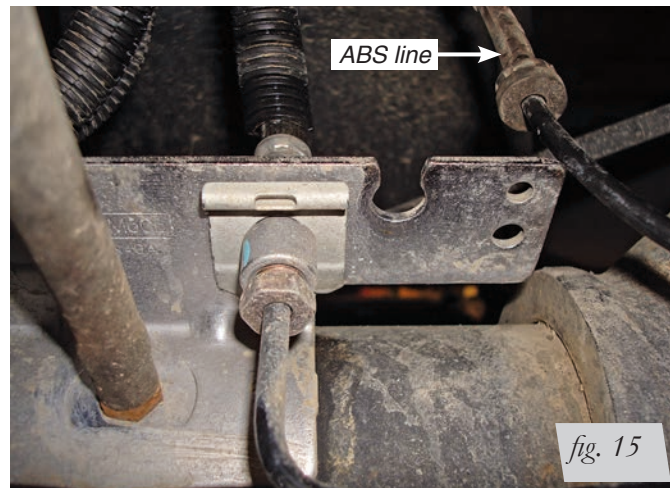

3. Set the Clamp (W) around the left ABS and Brake line as shown in Figure 16. Insert a Hex Bolt (X) and Flat Washer (M) through the clamp.

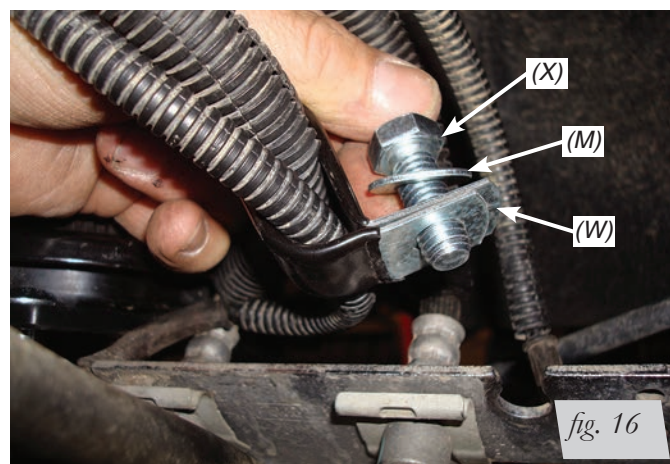

1. Install the bolt through the existing hole in the lower bracket that the right side ABS line was removed from (Fig. 17). Cap with a Flat Washer (M) and Nylon Lock Nut (U). Position clamp so that the lines turn 90° coming out of the fitting.

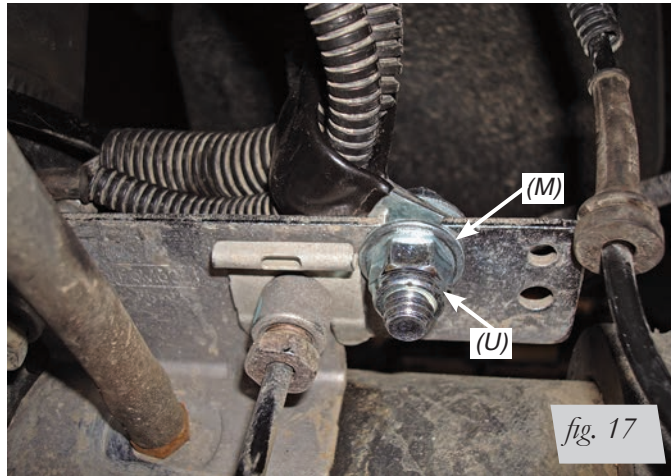

2. Tie off the left ABS line removed from the bracket, to the right ABS line moved with a Tie Strap (BB) (Fig. 18).

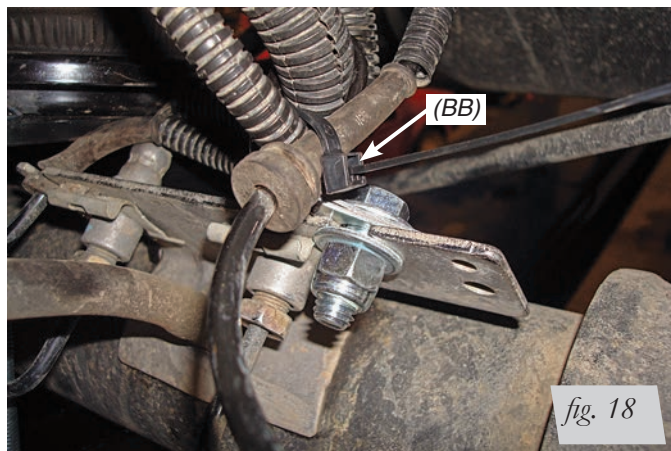

3. Left side (driver's): set one of the lower brackets on the axle making sure the inside leg is outboard (leaf spring side) of the ABS line bracket on the axle (Figs. 19 & 20). It may be necessary to angle the lower bracket into position. Make sure the lower bracket is pushed against the leaf spring and in between the stock U-bolts.

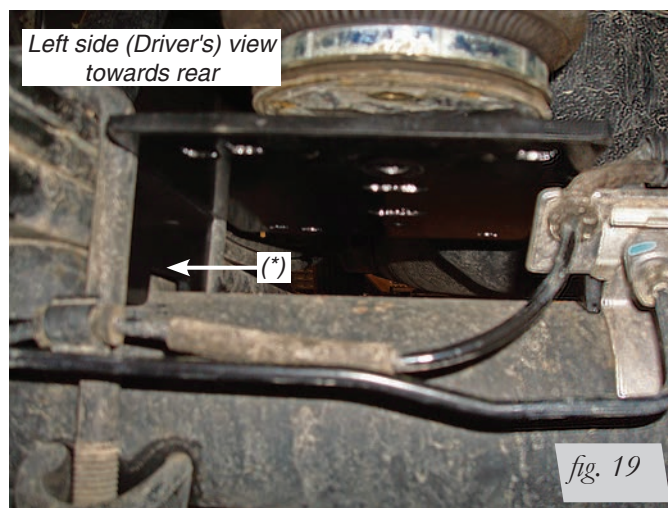

(* Push the bracket against the leaf spring in between the stock U-bolts.

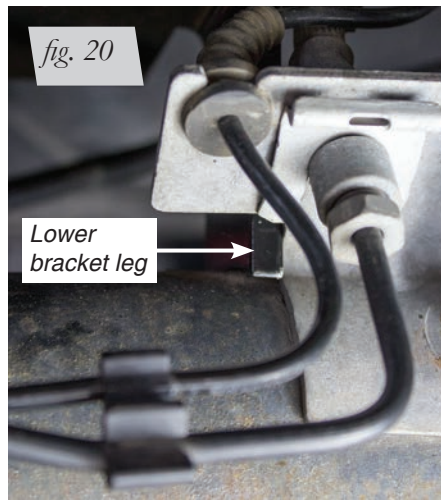

4. Insert the long carriage bolts (T) into the bottom bracket.

NOTE

The inside square holes must be used for the carriage bolts (Fig. 21).

Install the lower clamp bars (N) over the carriage bolts installed previously and cap with flat washers (M) and nylon lock nuts (U). Torque the lower nuts evenly to 10 lb.-ft. (14Nm).

NOTE

Make sure the lower bracket stays against the leaf spring and in between the stock U-bolts.

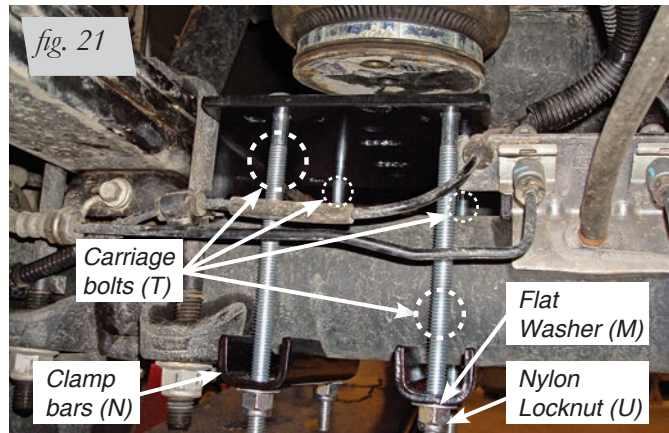

5. Right side (passenger's): set the other lower bracket onto the axle making sure the bracket is pushed against the leaf spring and is in between the stock U-bolts. Attach the lower bracket as noted in the Figure 12 and 13 instructions noted previously. Torque hardware evenly to 10 lb.-ft. (14Nm) (Figs. 22 & 23).



Right side (passenger's) view towards front of finished installation torqued to 10 lb.-ft. (14Nm).



Right side (passenger's) view towards rear of finished installation torqued to 10 lb.-ft. (14Nm).

fig. 23

LOWER BRACKET TO BELLOWS INSTALLATION

All years will attach in the same way. The late model is being used for the illustrations.

1. Set a roll plate on top of the lower bracket making sure it is positioned correctly to nest over the bottom of the bellows. Try to line the holes in the roll plate up to the lower bracket as close as you can, then raise the axle up so that the roll plate just touches the bellows.
2. Looking below, line up the hole in the roll plate (H) with the bellows and attach using the 3/8 Hex Head bolt (K) lock washer (L) and flat washer (M) (Fig. 24). Repeat for the other mounting hole in the bracket. Since it will be hard to torque this bolt, unless using a crows foot wrench adapter, just tighten the hardware securely (no more than 20 lb.-ft. [27Nm]). Repeat for the other side.

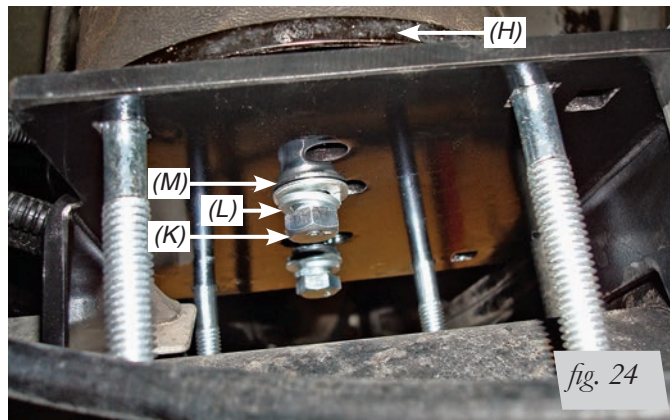

fig. 24

FINISHING THE INSTALLATION

1. Once the left (driver's) side assembly has been completed, review the RSC Brake/ABS line clearance and adjust if necessary (Fig. 25).

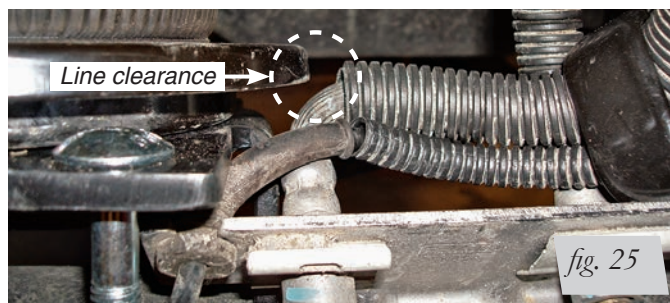

fig. 25

2. Drop the axle or raise the frame and remove the jack stands.

INSTALLING THE HEAT SHIELD

Exhaust Clearance Modification

1. Check the exhaust clearance and ensure that it is 2-3 inches from the air cylinder.

Positioning the Heat Shield

NOTE

The heat shield is installed on the exhaust pipe at the closest point to the air spring to protect the unit from the radiant heat of the exhaust system.

2. Attach radiator clamps loosely around the exhaust pipe nearest to the spring.
3. Bend the heat shield tab out at a 90° angle and again half the distance up at a 90° angle to form an “L” shape. Repeat on the other tab (Fig. 26). Position heat shield and insert the heat shield tabs beneath the two radiator clamps. Tighten the clamps.

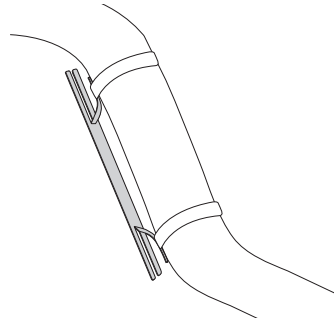

fig. 26

4. Bend the heat shield to form it around the tail pipe. Be sure to maintain a “dead air” space of 1/2” to 1” between the tail pipe and the heat shield (Fig. 27).

NOTE

Make sure the installation does not interfere with moving parts, gas lines, etc.

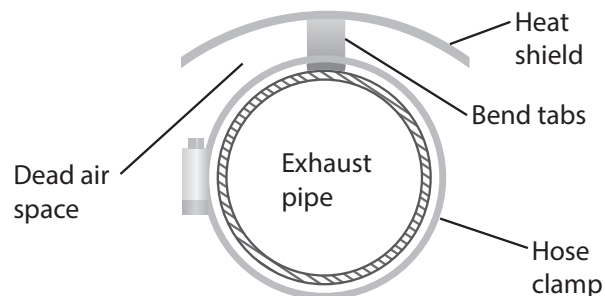

fig. 27

5. Install the hose heat shield supplied on the right (passenger's) side hose where hose will go into the bellows assembly. See Figure 34 for the finished heat shield installation.

Installing the Air Lines

This section explains how to set up the air spring kit to be controlled with Schrader valves and a separate compressed air source. An on-board air compressor system allows for hassle-free control of the air springs. Learn more about Air Lift control systems at www.airliftcompany.com/products/compressor-systems.

1. Choose a convenient location for mounting the inflation valves. Popular locations for the inflation valve are:
 - a. The wheel well flanges
 - b. The license plate recess in bumper
 - c. Under the gas cap access door
 - d. Through the license plate

NOTE

Whatever the chosen location, make sure there is enough clearance around the inflation valves for an air chuck.

2. Drill 5/16" holes to install the inflation valves.

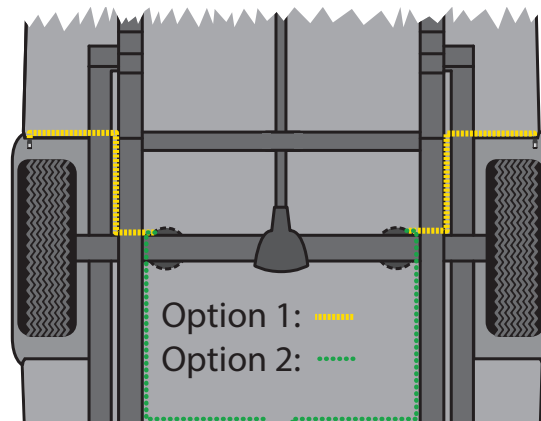
fig. 27

3. If installing dual air lines, cut the air line assembly in two equal lengths.
4. Place a 5/16" nut and star washer on the air valve. Leave enough of the inflation valve in front of the nut to extend through the hole and have room for the rubber washer, flat washer, and 5/16" nut and cap. There should be enough valve exposed after installation – approximately 1/2" – to easily apply a pressure gauge or an air chuck (Fig. 28).
5. Push the inflation valve through the hole and use the rubber washer, flat washer, and another 5/16" nut to secure it in place. Tighten the nuts to secure the assembly.

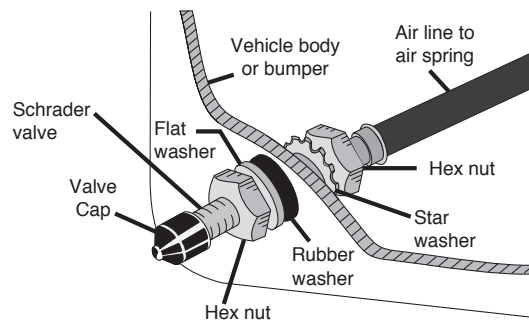
fig. 28

6. Route the air line along the frame to the fitting on the air spring (Fig. 27). Keep AT LEAST 6" of clearance between the air line and the exhaust system. Avoid sharp bends and edges. Use plastic tie straps to secure the air line to fixed points along the chassis. Be sure that the tie straps are tight, but do not pinch the air line. Leave at least 2" of slack to allow for any movement that might pull on the air line.
7. Cut off the air line, leaving approximately 12" of extra air line. A clean square cut will prevent leaks. Insert the air line into the air fitting. This is a push-to-connect fitting. Simply push the air line into the 90° swivel fitting until it bottoms out (9/16" of air line should be in the fitting).

TIPS FOR INSTALLING AIR LINES

When cutting air lines, use a sharp knife or a hose cutter and make clean, square cuts (Fig. 29). Do not use scissors or wire cutters because these tools may deform the air line, causing it to leak around fittings. Do not cut the lines at an angle.

Do not bend the 1/4" hose at a radius of less than 1" or bend the 3/8" hose at a radius of less than 1 1/2". Do not put side load pressure on fitting. The hose should be straight beyond the fitting for 1" before bending.

Inspect hose for scratches that run lengthwise on hose prior to installation. Contact Air Lift customer service at (800) 248-0892 if the air line is damaged.



To watch a video demonstrating proper air line cutting, go to air-lift.co/cuttingairline.

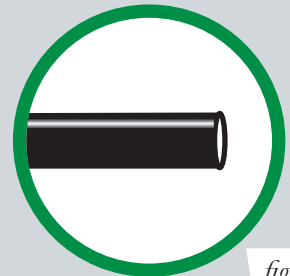

fig. 29



FINISHED INSTALLATION (FOR 2004-08 MODELS)



fig. 30

Left side (driver's): rear view of installation.



fig. 31

Left side (driver's): front view of installation.

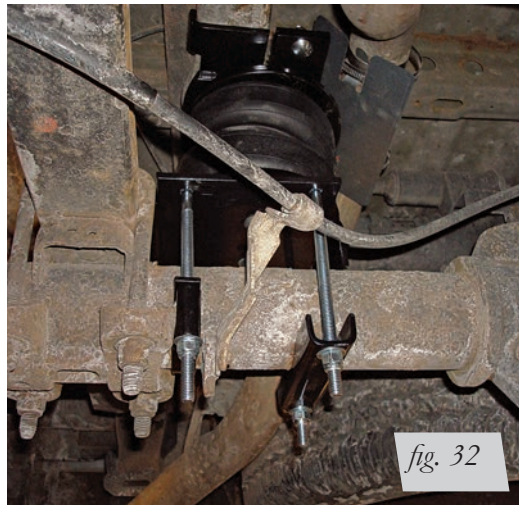

fig. 32

Right side (passenger's): front view of installation.



fig. 33

Right side (passenger's): rear view of installation.

FINISHED INSTALLATION (FOR 2009 & UP MODELS)



Left side (driver's): rear view of installation.



Left side (driver's): front view of installation.



Right side (passenger's): front view of installation.



Right side (passenger's): rear view of installation.

Before Operating

CHECKING FOR LEAKS

1. Inflate the air spring to 30 PSI.
2. Spray all connections and the inflation valves with a solution of 1/5 liquid dish soap and 4/5 water. Spot leaks easily by looking for bubbles in the soapy water.
3. After the test, deflate the springs to the minimum pressure required to restore the system to normal ride height. Do not deflate to lower than 5 PSI.
4. Check the air pressure again after 24 hours. A 2-4 PSI loss after initial installation is normal. Retest for leaks if the loss is more than 5 PSI.

FIXING LEAKS

1. If there is a problem with the swivel fitting:
 - a. Check the air line connection by deflating the spring and removing the line by pulling the collar against the fitting and pulling firmly on the air line. Trim 1" off the end of the air line. Be sure the cut is clean and square (see Fig. E.4). Reinsert the air line into the push-to-connect fitting.
 - b. Check the threaded connection by tightening the swivel fitting another half turn. If it still leaks, deflate the air spring, remove the fitting, and re-coat the threads with thread sealant. Reinstall by hand tightening as much as possible and then use a wrench for an additional two turns.
2. If there is a problem with the inflation valve:
 - a. Check the valve core by tightening it with a valve core tool.
 - b. Check the air line by removing the air line from the barbed type fitting. Cut the air line off a few inches in front of the fitting and use a pair of pliers or vice grips to pull/twist the air line off of the fitting.



CAUTION

DO NOT CUT OFF THE AIR LINE COMPLETELY AS THIS WILL USUALLY NICK THE BARB AND RENDER THE FITTING USELESS.

3. If the preceding steps have not resolved the problem, call Air Lift customer service at **(800) 248-0892**.

INSTALLATION CHECKLIST

- Clearance test** — Inflate the air springs to 75-90 PSI and make sure there is at least 1/2" clearance from anything that might rub against each sleeve. Be sure to check the tire, brakes, frame, shock absorbers and brake cables.
- Leak test before road test** — Inflate the air springs to 75-90 PSI and check all connections for leaks. All leaks must be eliminated before the vehicle is road tested.
- Heat test** — Be sure there is sufficient clearance from heat sources, at least 6" for air springs and air lines. If a heat shield was included in the kit, install it. If there is no heat shield, but one is required, call Air Lift customer service at **(800) 248-0892**.
- Fastener test** — Recheck all bolts for proper torque.
- Road test** — The vehicle should be road tested after the preceding tests. Inflate the springs to recommended driving pressures. Drive the vehicle 10 miles and recheck for clearance, loose fasteners and air leaks.
- Operating instructions** — If professionally installed, the installer should review the operating instructions with the owner. Be sure to provide the owner with all of the paperwork that came with the kit.

POST-INSTALLATION CHECKLIST

- Overnight leak down test** — Recheck air pressure after the vehicle has been used for 24 hours. If the pressure has dropped more than 5 PSI, then there is a leak that must be fixed. Either fix the leak yourself or return to the installer for service.
- Air pressure requirements** — It is important to understand the air pressure requirements of the air spring system. Regardless of load, the air pressure should always be adjusted to maintain adequate ride height at all times while driving.
- Thirty-day or 500-mile test** — Recheck the air spring system after 30 days or 500 miles, whichever comes first. If any part shows signs of rubbing or abrasion, the source should be identified and moved, if possible. If it is not possible to relocate the cause of the abrasion, the air spring may need to be remounted. If professionally installed, the installer should be consulted. Check all fasteners for tightness.

Product Use, Maintenance and Servicing

Minimum Recommended Pressure	Maximum Air Pressure
5 PSI	100 PSI

MAINTENANCE GUIDELINES

NOTE

By following the steps below, vehicle owners will obtain the longest life and best results from their air springs.

1. Check air pressure weekly.
2. Always maintain normal ride height. Never inflate beyond 100 PSI.
3. If you develop an air leak in the system, use a soapy water solution (1/5 liquid dish soap and 4/5 water) to check all air line connections and the inflation valve core before deflating and removing the air spring.

CAUTION

FOR SAFETY AND TO PREVENT POSSIBLE DAMAGE TO THE VEHICLE, DO NOT EXCEED MAXIMUM GROSS VEHICLE WEIGHT RATING (GVWR), AS INDICATED BY THE VEHICLE MANUFACTURER. ALTHOUGH THE AIR SPRINGS ARE RATED AT A MAXIMUM INFLATION PRESSURE OF 100 PSI, THE AIR PRESSURE ACTUALLY NEEDED IS DEPENDENT ON LOAD AND GVWR.

4. Loaded vehicles require at least 25 PSI. A “loaded vehicle” refers to a vehicle with a heavy bed load, a trailer or both. Never exceed GVWR, regardless of air spring, air pressure or other load assist. The springs in this kit will support approximately 40 pounds of load (combined on both springs) for each 1 PSI of pressure. The required air pressure will vary depending on the state of the original suspension. Operating the vehicle below the minimum air spring pressure will void the Air Lift warranty.
5. When increasing load, always adjust air pressure to maintain normal ride height. Increase or decrease pressure from the system as necessary to attain normal ride height for optimal ride and handling. Remember that loads carried behind the axle (including tongue loads) require more leveling force (pressure) than those carried directly over the axle.
6. Always add air to springs in small quantities, checking the pressure frequently.
7. Should it become necessary to raise the vehicle by the frame, make sure the system is at minimum pressure (5 PSI) to reduce the tension on the suspension/brake components. Use of on-board leveling systems do not require deflation or disconnection.
8. Periodically check the air spring system fasteners for tightness. Also, check the air springs for any signs of rubbing. Realign if necessary.
9. On occasion, give the air springs a hard spray with a garden hose to remove mud, sand, gravel or other debris.

TUNING THE AIR PRESSURE

Pressure determination comes down to three things — level vehicle, ride comfort and stability.

1. Level vehicle

If the vehicle's headlights are shining into the trees or the vehicle is leaning to one side, then it is not level (Fig. 39). Raise the air pressure to correct either of these problems and level the vehicle.

2. Ride comfort

If the vehicle has a rough or harsh ride it may be due to either too much pressure or not enough (Fig. 40). Try different pressures to determine the best ride comfort.

3. Stability

Stability translates into safety and should be the priority, meaning the driver may need to sacrifice a perfectly level and comfortable ride. Stability issues include roll control, bounce, dive during braking and sponginess (Fig. 41). Tuning out these problems usually requires an increase in pressure.

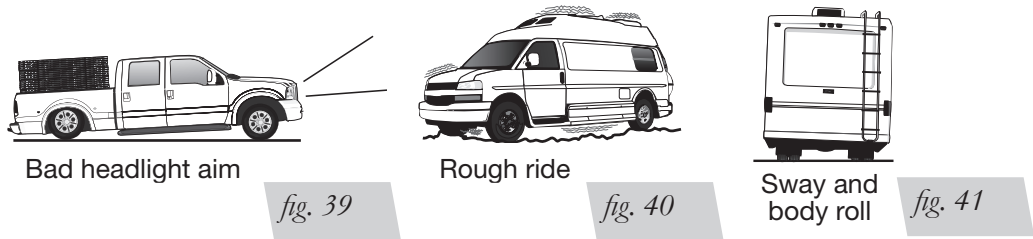

GUIDELINES FOR ADDING AIR

1. Start with the vehicle level or slightly above.
2. When in doubt, always add air.
3. If the front of the vehicle dives while braking, increase the pressure in the front air bags, if equipped.
4. If it is ever suspected that the air bags have bottomed out, increase the pressure. (Fig. 42)
5. Adjust the pressure up and down to find the best ride.
6. If the vehicle rocks and rolls, adjust the air pressure to reduce movement.
7. It may be necessary to maintain different pressures on each side of the vehicle. Loads such as water, fuel, and appliances will cause the vehicle to be heavier on one side (Fig. 43). As much as a 50 PSI difference is not uncommon.

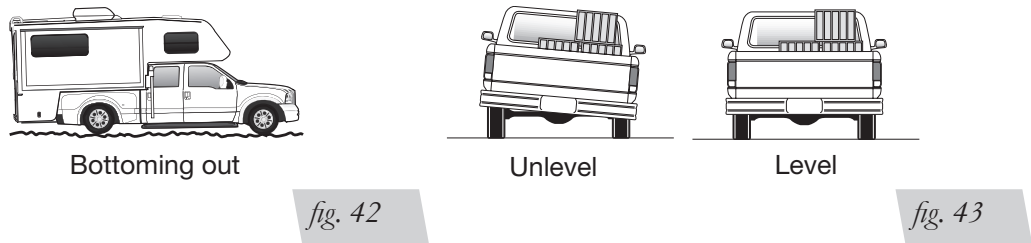

Troubleshooting Guide

PROBLEM	CAUSE	SOLUTION
System won't maintain pressure overnight.	Improperly installed air line, air line has holes or cracks.	Leak test the air line connections, the threaded connection into the air spring, and all fittings in the control system.
Compressor runs all the time.	The compressor relay is defective or there is a leak in the air lines.	Replace the relay or find the air leak.
Air spring or tank leak.	Fitting seal or air line is compromised.	Check to make sure air lines are seated in connectors. Inspect fittings with soapy water. Trim hose or re-seal fitting. Ensure lines are cut straight.
Corner won't raise or air leak develops.	Look for a kink or fold in the air line.	Replace any air line that has been kinked.

FREQUENTLY ASKED QUESTIONS

Q. Will installing air springs increase the weight ratings of a vehicle?

No. Adding air springs will not change the weight ratings (GAWR, GCWR and/ or GVWR) of a vehicle. Exceeding the GVWR is dangerous and voids the Air Lift warranty.

Q. Is it necessary to keep air in the air springs at all times and how much pressure will they need?

For LoadLifter 5000 Ultimate, the recommended minimum air pressure is 5 PSI, but it can safely be run at zero air pressure.

Q. Is it necessary to add a compressor system to the air springs?

No. Air pressure can be adjusted with any type of compressor as long as it can produce sufficient pressure to service the springs. Even a bicycle tire pump can be used, but it's a lot of work.

Q. How long should air springs last?

If the air springs are properly installed and maintained they can last indefinitely.

Q. Will raising the vehicle on a hoist for service work damage the air springs?

No. The vehicle can be lifted on a hoist for short-term service work such as tire rotation or oil changes. However, if the vehicle will be on the hoist for a prolonged period of time, support the axle with jack stands in order to take the tension off of the air springs.



Notes



Limited Warranty and Return Policy

WHAT THIS WARRANTY COVERS

Air Lift Company provides a warranty to the original purchaser of its Load Support Products, for the periods of time listed below, by product line, from the date of original purchase, that the products will be free from defects in workmanship and materials when used on cars and trucks as specified by Air Lift Company and under normal operating conditions, subject to the requirements and exclusions set forth below.

WHAT THIS WARRANTY DOES NOT COVER

The warranty does not apply to products that have been improperly applied, improperly installed, or which have not been maintained in accordance with installation instructions furnished with all products. This warranty does not apply and is void if damage or failure is caused by: accident, abuse, misuse (including but not limited to racing or off-road activities or commercial use), abnormal use, faulty installation, liquid contact, fire, earthquake or other external cause; operating the product outside Air Lift Company's instructions, specifications or guidelines; or service, alteration, maintenance or repairs performed by anyone other than Air Lift Company to the product from its purchased condition. This warranty also does not apply to: consumable parts, such as batteries; cosmetic damage, including but not limited to scratches or dents; defects caused by normal wear and tear or otherwise due to the normal aging of the product, or if any serial or identification number has been removed or defaced from the product. Air Lift Company reserves the right to change the design of any product without assuming any obligation to modify any product previously manufactured.

LIMITATION OF LIABILITY

To the extent permitted by law, this warranty and the remedies set forth herein are exclusive and in lieu of all other warranties, remedies and conditions, whether oral, written, statutory, express or implied. AIR LIFT COMPANY DISCLAIMS ALL STATUTORY AND IMPLIED WARRANTIES, INCLUDING WITHOUT LIMITATION, WARRANTIES OF MERCHANTABILITY AND FITNESS FOR A PARTICULAR PURPOSE AND WARRANTIES AGAINST HIDDEN OR LATENT DEFECTS TO THE EXTENT PERMITTED BY LAW. To the extent such warranties cannot be disclaimed, such implied warranties shall apply only for the warranty period specified above. Please note that some states do not allow limitation on how long an implied warranty (or condition) lasts. So the above limitation may not apply to you. Except as provided in this warranty and to the extent permitted by law, Air Lift Company shall not be liable for any direct, special, incidental or consequential damages resulting from any breach of warranty or condition, or arising in connection with the sale, use or repair of air lift products, or under any other legal theory, including but not limited to loss of use, loss of revenue, loss of actual or anticipated profits, loss of the use of money, loss of business, loss of opportunity, loss of goodwill, and loss of reputation. Air Lift Company's maximum liability shall not in any case exceed the purchase price paid by you for the Air Lift product. Please note that some states do not allow the exclusion or limitation of incidental or consequential damages, so the above limitation or exclusion may not apply to you.

HOW TO GET SERVICE

If a defect in workmanship or materials causes your Air Lift product to become inoperable within the warranty period, before returning any defective product, call Air Lift Company at (800) 248-0892 in the U.S. and Canada (elsewhere, (517) 322-2144) to obtain a Returned Materials Authorization (RMA) number. The consumer shall be responsible for removing (labor charges) the defective product from the vehicle and returning it, shipping costs prepaid, to Air Lift Company for verification. Returns to Air Lift Company must be postage prepaid and sent to: Air Lift Company • 2727 Snow Road • Lansing, MI • 48917. You must prove to the satisfaction of Air Lift Company the date of original purchase of your Air Lift product. You must also enclose the RMA number and a return address. A minimum \$10 shipping and handling charge will apply to all warranty claims. You must also pack the product to minimize the risk of it being damaged in transit. If we receive a product in damaged condition as the result of shipping, we will notify you and you must seek a claim with the shipper.

WHAT AIR LIFT COMPANY WILL DO

If you submit a valid claim to Air Lift Company during the warranty period, Air Lift Company will, at its option, repair your Air Lift product or furnish you with a new or rebuilt product. Air Lift Company will not reimburse you for repairs or replacement parts provided by other parties. Your repaired or replacement Air Lift product will be returned to you (subject to payment of the required warranty claim shipping and handling charge) and it will be covered under the warranty for the balance of the warranty period, if any. When a product or part is replaced, any replacement item becomes your property and the replaced item becomes property of Air Lift Company. You are responsible for installation/reinstallation (labor charges) of the product.

HOW THE LAW RELATES TO THIS WARRANTY

This warranty gives you specific legal rights and you may also have other rights which vary from state to state. By this warranty, Air Lift Company does not limit or exclude your rights except as allowed by law. To fully understand your rights, you should consult the laws of your state.

SPECIFIC LOAD SUPPORT WARRANTY PERIODS BY PRODUCT LINE

LoadLifter 5000™ Ultimate.....	Lifetime Limited	WirelessAIR™.....	2 Year Limited
LoadLifter 5000™.....	Lifetime Limited	WirelessONE™.....	2 Year Limited
RideControl™.....	Lifetime Limited	LoadController™ Single and Dual.....	2 Year Limited
Air Lift 1000™.....	Lifetime Limited	LoadController™ I and II.....	2 Year Limited
AirCell™.....	Lifetime Limited	SmartAir™ II.....	2 Year Limited
SlamAir™.....	Lifetime Limited	Other Accessories.....	2 Year Limited

Replacement Information

If you need replacement parts, contact the local dealer or call Air Lift customer service at (800) 248-0892. Most parts are immediately available and can be shipped the same day.

Contact Air Lift Company customer service at (800) 248-0892, first if:

- Parts are missing from the kit.
- Need technical assistance on installation or operation.
- Broken or defective parts in the kit.
- Wrong parts in the kit.
- Have a warranty claim or question.

Contact the retailer where the kit was purchased:

- If it is necessary to return or exchange the kit for any reason.
- If there is a problem with shipping if shipped from the retailer.
- If there is a problem with the price.

Contact Information

If you have any questions, comments or need technical assistance, contact our customer service department by calling (800) 248-0892. For calls from outside the USA or Canada, our local number is (517) 322-2144.

For inquiries by mail, our address is PO Box 80167, Lansing, MI 48908-0167. Our shipping address for returns is 2727 Snow Road, Lansing, MI 48917.

You may also contact us anytime by e-mail at sales@airliftcompany.com or on the web at www.airliftcompany.com.

Need Help?

Contact Air Lift Company customer service department by calling (800) 248-0892. For calls from outside the USA or Canada, dial (517) 322-2144.



Thank you for purchasing Air Lift products — the professional installer's choice!

Air Lift Company • 2727 Snow Road • Lansing, MI 48917 or P.O. Box 80167 • Lansing, MI 48908-0167
Toll Free (800) 248-0892 • Local (517) 322-2144 • Fax (517) 322-0240 • www.airliftcompany.com

Printed in the USA
BGL 0616