

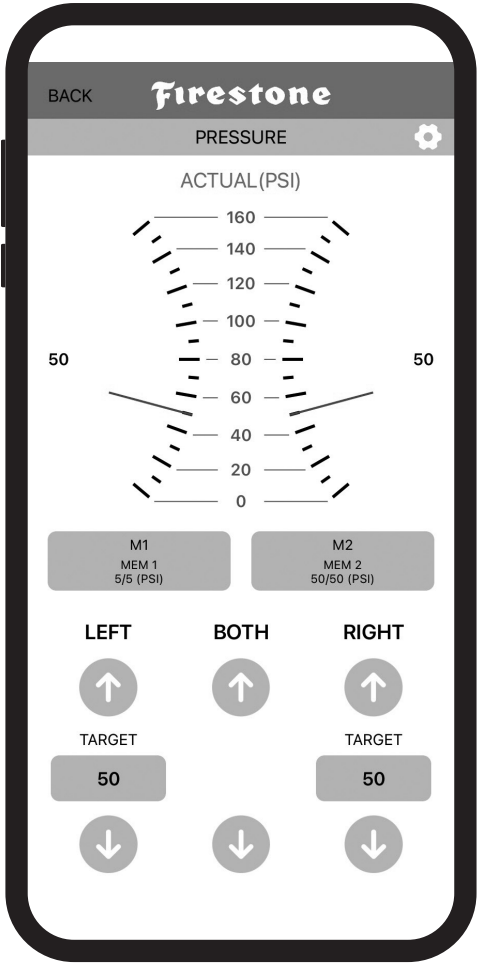

AIRIDE

firestoneairide.com

INSTALLATION INSTRUCTIONS



IMPORTANT

PLEASE DON'T HURT YOURSELF, THE KIT, OR YOUR VEHICLE. TAKE A MINUTE TO READ THIS IMPORTANT INFORMATION.

SAFE INSTALLATION

Please take all safety precautions during installation. A hydraulic jack can fail, and if that happens, you can be seriously hurt, or worse, if you are relying on it to hold up the vehicle. If you use a hydraulic jack, secure jack stands in the appropriate locations and chock any tires still touching the ground.

Wear safety glasses or goggles. Your eyes may be lower than some parts and pieces, and you don't want to lose an eye.

Remove the possibility of any electrical issues by disconnecting the negative battery cable.

VEHICLE GVWR

NEVER exceed the maximum load recommended by the vehicle manufacturer (GVWR). The GVWR can be found in your vehicle's owner's manual or on the data plate on the driver's side door. Consult your local dealership for additional GVWR specifications.

PRESSURE TO LOAD

Be sure to review the load limits noted in the Air Spring Kit Installation Instructions (sold separately).

APPROPRIATE AIR PRESSURE

For best ride, use only enough air pressure in the Air Springs to level the vehicle when viewed from the side (front to rear). This will vary, depending on the load, location of the load, condition of the existing suspension, and personal preference.

**ONCE INSTALLED SUCCESSFULLY, FOLLOW THE PRESSURE REQUIREMENTS FOR THE AIR SPRINGS.
FOR FIRESTONE, GENERALLY:**

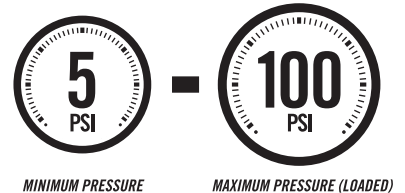





RED LABEL AIR SPRING REQUIREMENTS:





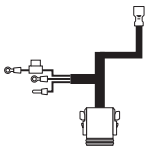
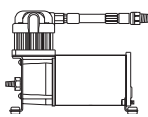
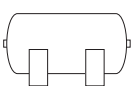

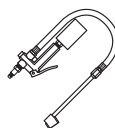











PARTS

Compare the parts below to your kit. Ensure you have all pieces, and organize them for an easier installation.

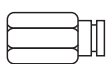
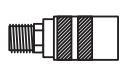
MAIN KIT CONTENTS

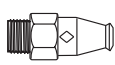
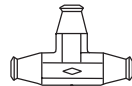
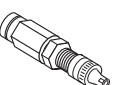
PT # 9965 <i>The 9961 ECU and 9962 Wire Harness are packaged inside one box under the 9965 part number.</i>		PT # 9961  x 1 ECU	PT # 9962  x 1 WIRE HARNESS
PT # 9287  x 1 AIR COMPRESSOR 450C	PT # 9126  x 1 AIR TANK 2 GALLON	PT # 9416  x 1 AIR TUBING (30 FEET)	
PT # 9194  x 1 EXTERNAL HOSE	PT # 9195  x 1 INFLATOR AND GAUGE KIT	PT # 9301  x 1 STORAGE BAG HEAVY DUTY	

A21-760-2631 HARDWARE PACK

PT # 3087  x 4 10-32 x 1" MACHINE SCREW	PT # 3093  x 2 10-32 x 3/4" MACHINE SCREW	PT # 0070  x 4 3/8-16 x 1.00 HEX HEAD CAP SCREW GR2
PT # 3421  x 1 10-16 x 3/4" SELF-TAPPING SCREW	PT # 3088  x 6 10-32 NYLOCK NUT	PT # 3067  x 4 3/8-16 HEX HEAD FLANGE CENTER LOCK NUT
PT # 3086  x 12 #10 FLAT WASHER	PT # 0071  x 8 3/8 FLAT WASHER	PT # 9483  x 1 INFLATION VALVE MOUNTING BRACKET
PT # 3046  x 3 1/4 STRAIGHT FITTING PTC	PT # 3083  x 1 1/4 NPT FEMALE 1/4 PTC	PT # 9196  x 1 DRY COUPLER FITTING
PT # 3146  x 1 1/4 NPT ANCHOR COUPLING	PT # 3055  x 1 1/8 NPT PUSH-TO-CONNECT STRAIGHT FITTING	PT # 3025  x 2 1/4 PUSH-TO-CONNECT TEE
PT # 3032  x 2 INFLATION VALVE AND VALVE CAP ASSEMBLY	PT # 9488  x 4 LARGE NYLON TIE	PT # 0899  x 4 THERMAL SLEEVE
PT # 9036  x 20 RED NYLON TIE		

CONTENTS AND OVERVIEW

PAGE **4** **PLANNING THE INSTALL**

PAGE **5** **PREPARE THE AIR COMPRESSOR AND TANK**

PAGE **6** **DRILL HOLES FOR AIR COMPRESSOR AND ECU**

PAGE **7** **INSTALL MAIN COMPONENTS**

PAGE **8** **INSTALL THE AIR TUBING**

PAGE **9** **INSTALL THE WIRE HARNESS**

PAGE **10** **INSTALL BULKHEAD ASSEMBLY, USING INFLATOR, CLEAN UP INSTALLATION**

PAGE **11** **ECU POWER UP/ APP PERFORMANCE**

PAGE **13** **USING THE AUXILIARY PORT**

PAGE **15** **USING THE AIR COMMAND™ DUAL APP**

PAGE **17** **TEST THE SYSTEM**

PAGE **18** **FIX AN AIR LEAK**

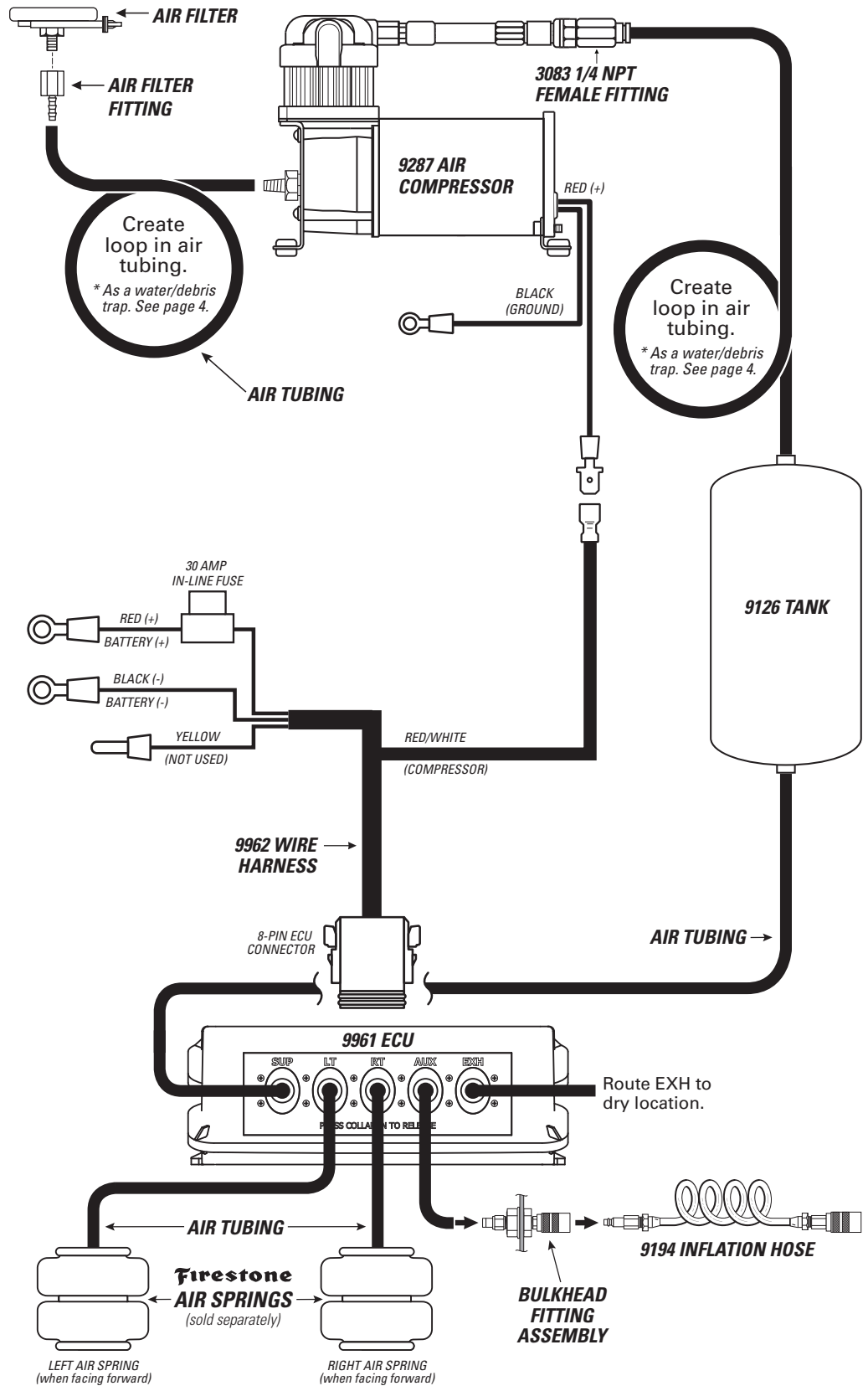

PLANNING THE INSTALL

THESE PLANNING STEPS WILL HELP YOU SAVE TIME AND WILL MAKE THE INSTALLATION EASIER.

DETERMINE THE MOUNTING LOCATION FOR THE AIR COMPRESSOR

- Provides ample air flow and is protected from airborne debris and moisture.
- Mount close enough to the ECU to allow Wire Harness connections to reach.
- If using the optional Firestone Air Accessory Mounting Kit, consider the guidelines above, and follow the kit's instructions.

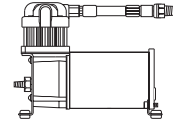

DETERMINE THE MOUNTING LOCATION FOR THE ECU

- Mount close enough to the Air Compressor to allow Wire Harness connections to reach.
- Allow room for Air Tubing to connect to the Air Fittings on the ECU.
- Allow room for the 8-pin ECU connector to connect to the ECU.
- Allow room for the Air Tubing to run without sharp curves or bends.
- Using supplied fasteners shown in Step 3 is recommended. If no other mounting option is available, see the sidebar on Step 2 for using the Large Nylon Ties.
- Select a location that is solid and secure on the body or frame of the vehicle, away from any moving parts, electrical or any other lines.

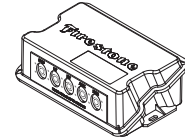

PLAN INSTALLATION ROUTES FOR WIRING AND AIR LINES

- Make sure the Wire Harness and Air Tubing are not exposed to sharp metal edges that can damage them.
- Use supplied Thermal Sleeves on Air Tubing when routing near heat sources.
- Use supplied Nylon Ties to secure Air Tubing and Wire Harness to the vehicle.
- Make a loop in the Air Tubing where shown. This creates a water/debris trap that protects the Air Compressor.
- Measure twice, cut once!

TAPE ALL ELECTRICAL CONNECTIONS

- Use electrical tape to appropriately secure and protect all electrical connections.

USING PUSH-TO-CONNECT FITTINGS FOR AIR LINES

Your kit includes Push-to-Connect fittings to connect the Air Tubing to hardware. Use the instructions below when using the Air Tubing.

- 1** Insert end of Air Tubing into Air Fitting.

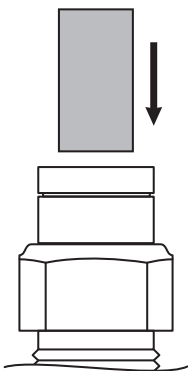

- 2** Push Air Tubing into Air Fitting as far as possible.

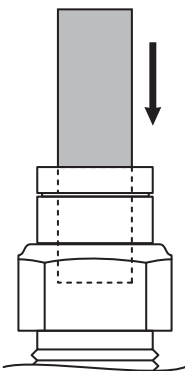

- 3** Gently pull on the Air Tubing to check for a secure fit.

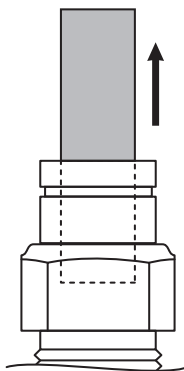

- 4** To remove, push down collar and gently pull Air Tubing away.

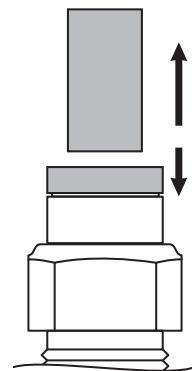

Removal Tip: Use a 1/4", 5/16", or 6mm open-ended wrench to push the collar down.

1

PREPARE THE AIR COMPRESSOR AND TANK

NOTE: Air Compressor can be mounted facing any direction.

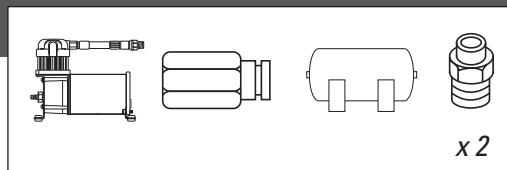

- 1 Install 1/4 Female NPT Push-to-Connect Straight Fitting on the Check Valve.

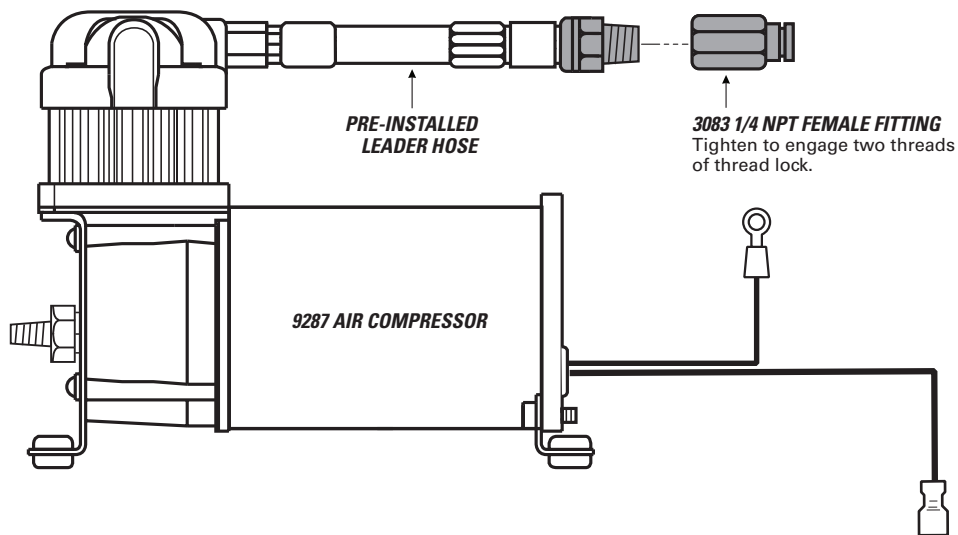

AIR FITTING
Tighten to engage two threads of thread lock.

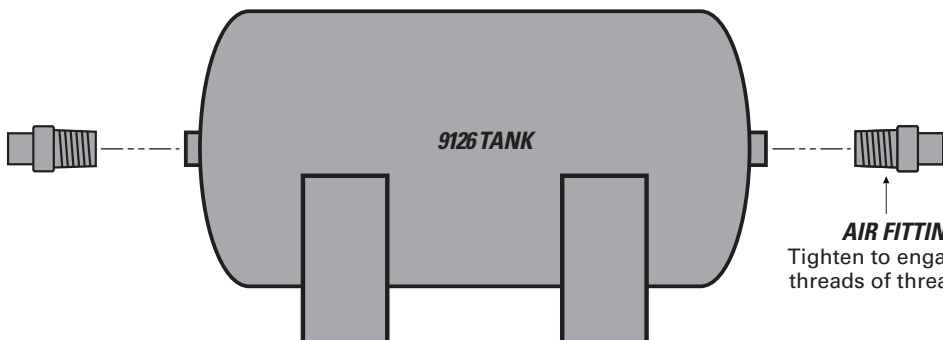

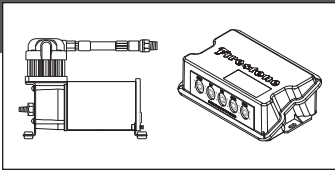

CHECK SURROUNDING AREA AND BACK SIDE OF MOUNTING LOCATION TO AVOID DRILLING INTO EXISTING LINES OR WIRING.



IF YOU ARE USING THE OPTIONAL FIRESTONE AIR ACCESSORY MOUNTING KIT, SKIP THIS STEP AND REFER TO THE MOUNTING KIT'S INSTRUCTIONS.

Drill within reach of the ground wire ring terminal on body or frame of vehicle or create a wire to link to the negative battery terminal. Minimum gauge of wire should be 12.

AIR ACCESSORY MOUNTING KIT CANNOT BE USED AS A GROUNDING LOCATION FOR THE AIR COMPRESSOR.

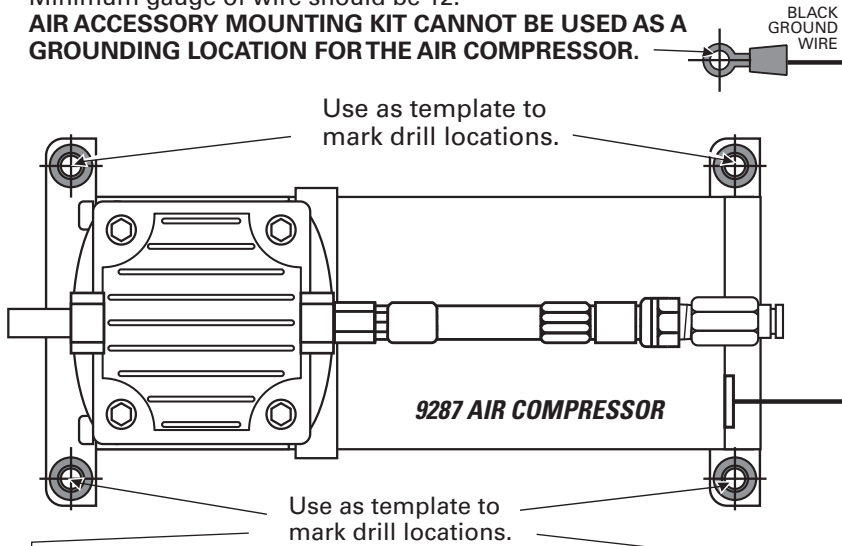

1 Using the Air Compressor and ECU as templates, mark drill locations as shown with a punch or marking tool.

2 Mark Air Compressor ground wire fastening location within reach of the ground wire ring terminal.

3 Drill 7/32" diameter holes. Remove any burrs and debris from drill holes.



ASSURE THAT YOU INSTALL THE AIR COMPRESSOR AND ECU CLOSE ENOUGH SO THE CONNECTORS ON THE WIRE HARNESS WILL REACH THEM BOTH.

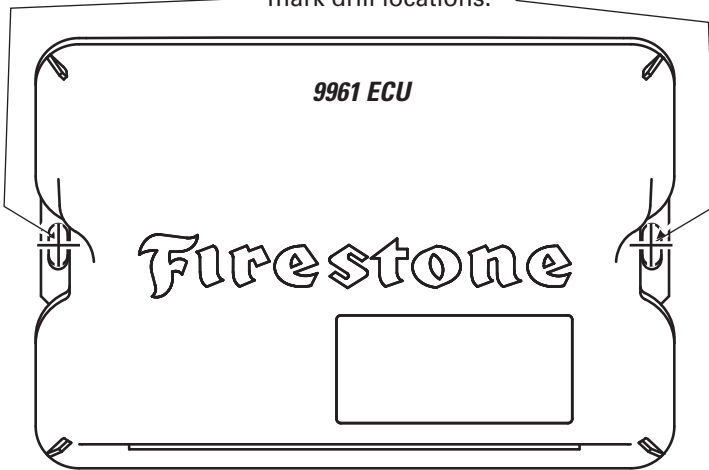

OPTIONAL ECU MOUNTING

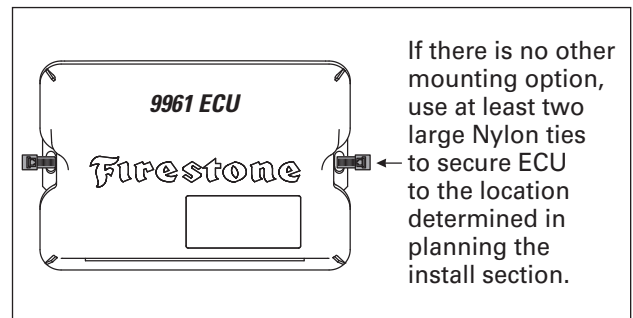

For tank mounts, make marks as shown below. The tank feet will mount at these locations.

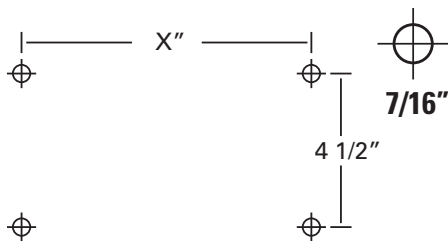

3

INSTALL MAIN COMPONENTS

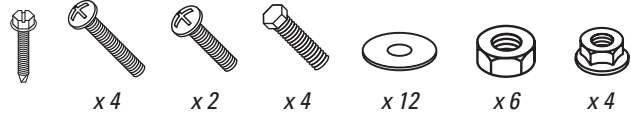

DO NOT OVER TIGHTEN MOUNTING BOLTS AND NUTS ON THE AIR COMPRESSOR. TOO MUCH TORQUE CAN CRUSH THE BRASS INSERTS AND RUBBER ISOLATORS.

1 Mount the Air Compressor to the drill hole location using the supplied fasteners. DO NOT OVERTIGHTEN.

2 Mount the ECU to the drill hole location using the supplied fasteners.

3 Mount the black ground wire ring terminal using the supplied fasteners. Assure that the ring terminal makes a solid contact with bare metal for a proper ground.

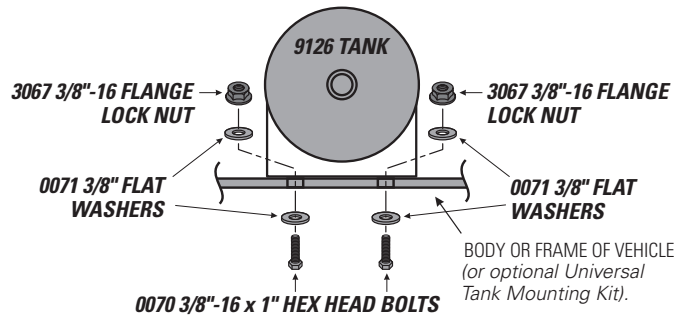
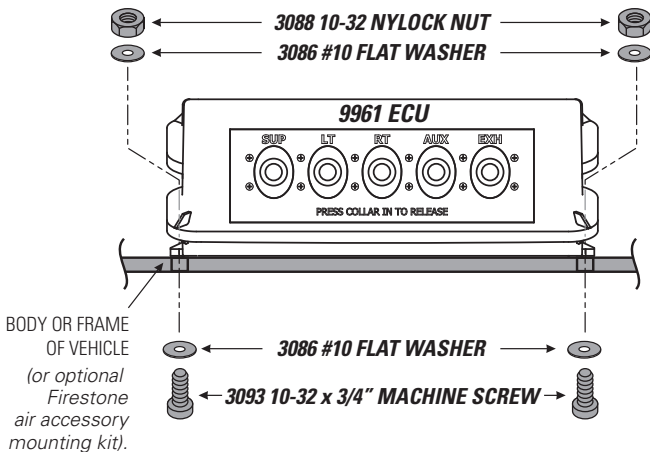
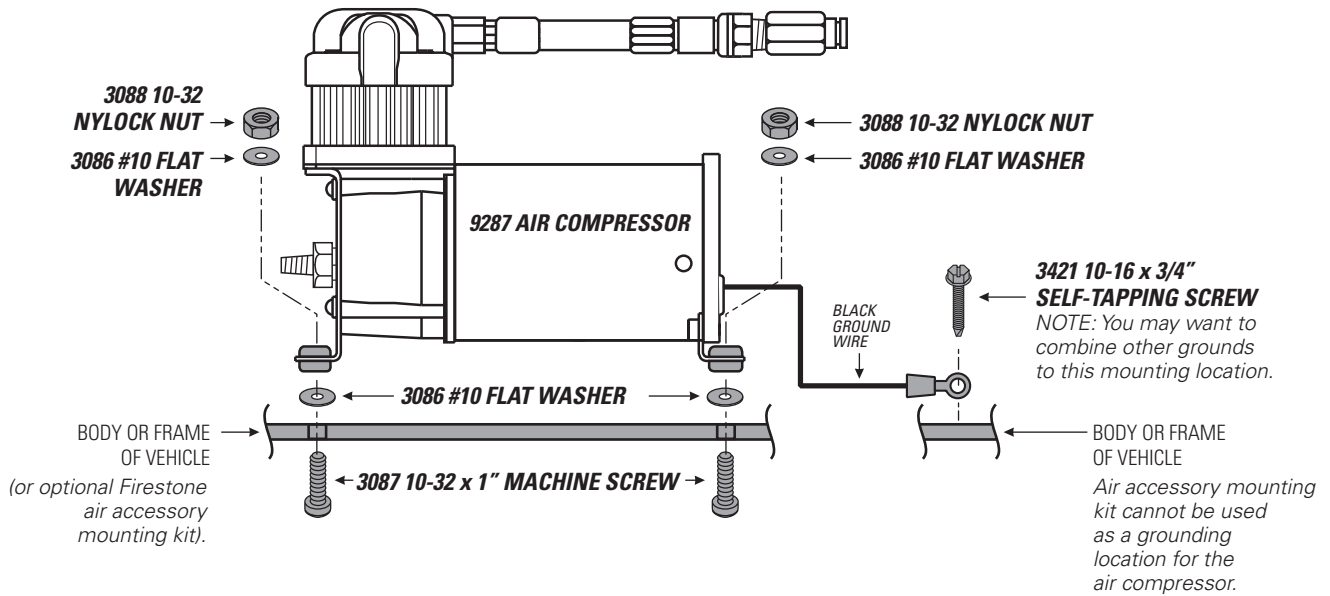



EXHAUST ALL AIR FROM THE SYSTEM PRIOR TO RELEASING AIR TUBING FROM AIR FITTINGS.



1 Route the Air Tubing from the 1/4" NPT female fitting to the tank and from the tank to the Supply (SUP) Air Fitting on the ECU, leaving room to secure it safely. Use the guidelines on page 4 for proper push-to-connect fitting install.

2 Repeat Step 1 to route Air Tubing from the ECU to the Air Springs. Use the RT and LT Air Fittings on the ECU.

3 Install Air Tubing to the Exhaust (EXH) Air Fitting to reduce exhaust noise and prevent dirt from clogging the port (recommended for off-road or dirty environments). Do not exceed 16" of Air Tubing, and secure it so the end turns to the ground.

4 Use supplied Nylon ties to install the air filter in a dry, secure place, away from dirt and debris. Periodically check the air filter during operation, and replace it when it becomes dirty.

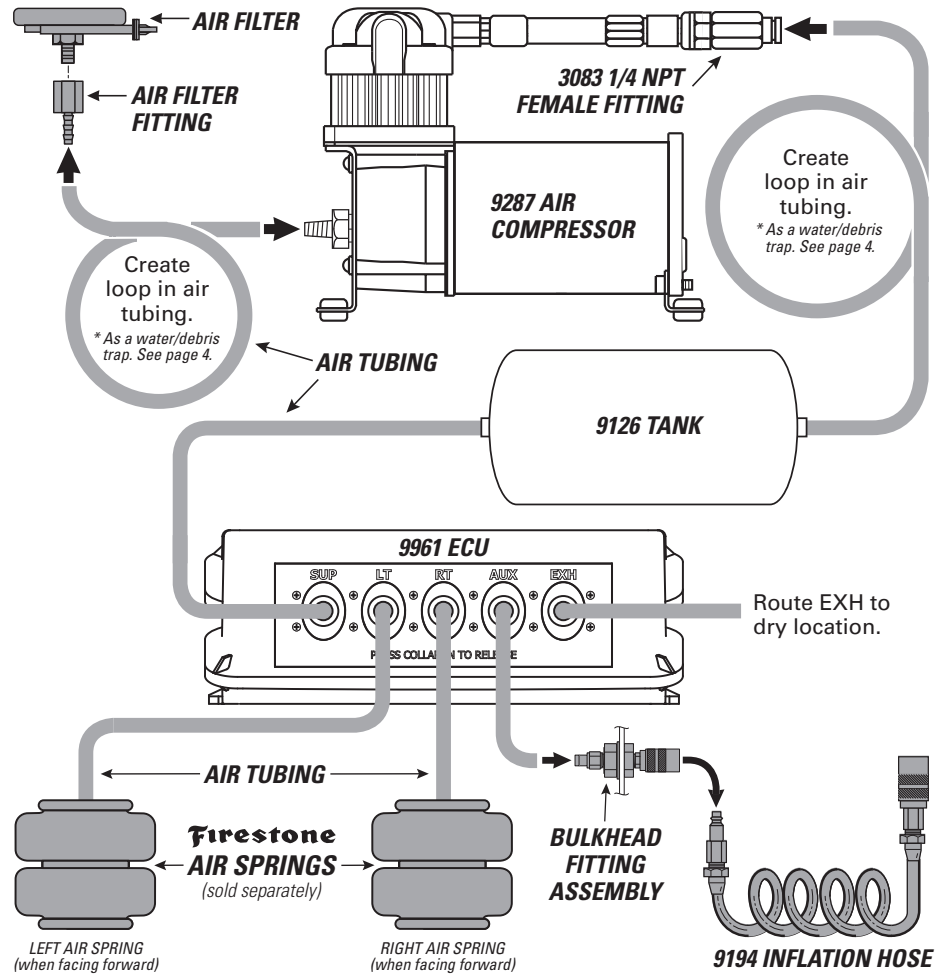

DO

Make sure the cut is as square as possible. Use a tube cutter or very sharp utility knife.

DON'T

Fold or kink the Air Tubing. Cut the Air Tubing at an angle. Use pliers, scissors, snips, saws, or side cutters.

PROPER AND IMPROPER CUTS IN THE AIR TUBING

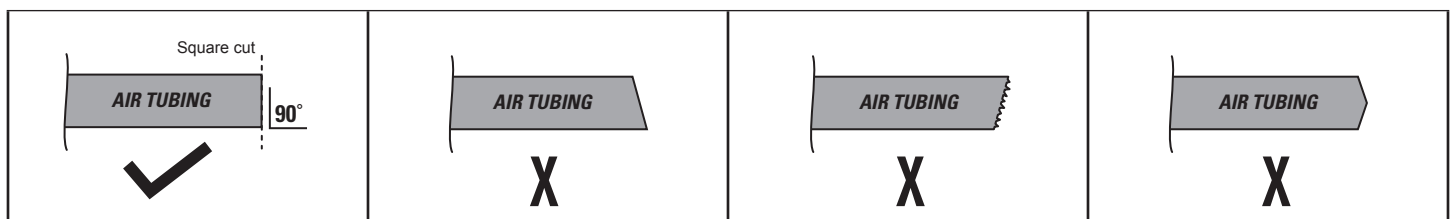

5

INSTALL THE WIRE HARNESS

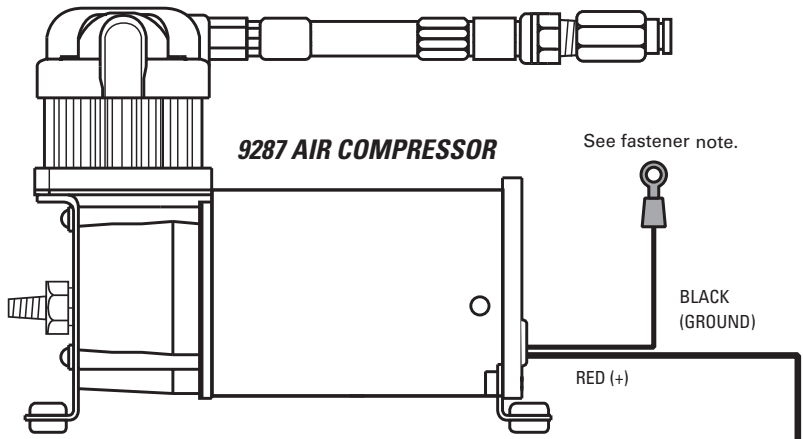
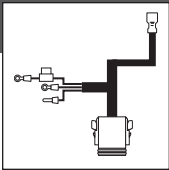

1 Route the Wire Harness in the most protected manner possible, and securely make all connections as shown.



Why ground the Wire Harness to the battery? The ECU needs a good, clean ground for optimal accuracy. The Air Compressor can ground to the frame, but the ECU cannot.

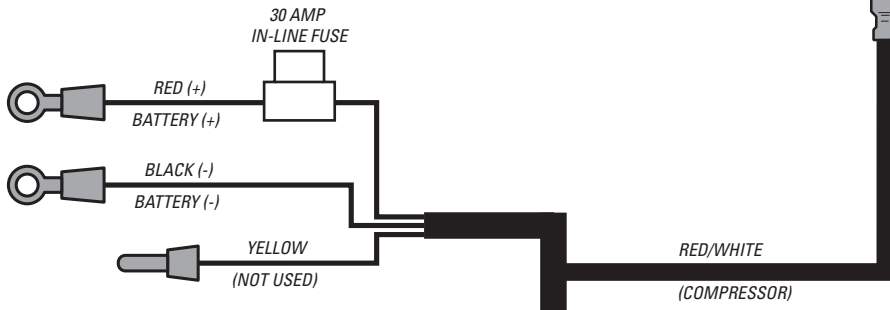

9962 WIRE HARNESS

8-PIN ECU CONNECTOR

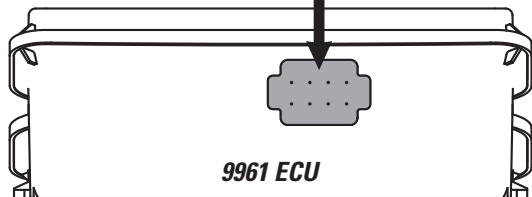

ECU INDICATOR LIGHTS (Inside Case)

RED LED GREEN LED

9961 ECU

Firestone

LEDs off – ECU off

Red LED flashing – Errors are present

Green LED flashing – Bluetooth not connected, normal operation

Green LED solid – Bluetooth connected, Normal operation

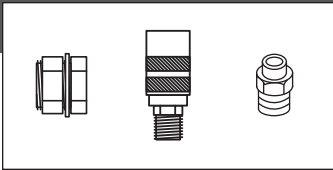

1 Determine a suitable location to mount the bulkhead assembly and fittings. This area should be convenient to access and safe from debris. Make sure you have room to attach the inflation hose.

2 Drill a 3/4" hole in the selected mounting location and install the bulkhead assembly components, Air Fitting and dry coupler fitting, as shown.

3 Install air tubing from the push-to-connect T-fitting between the air tank and the ECU to the Air Fitting installed into the bulkhead assembly.

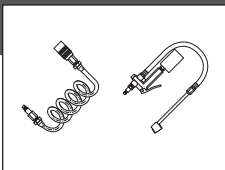
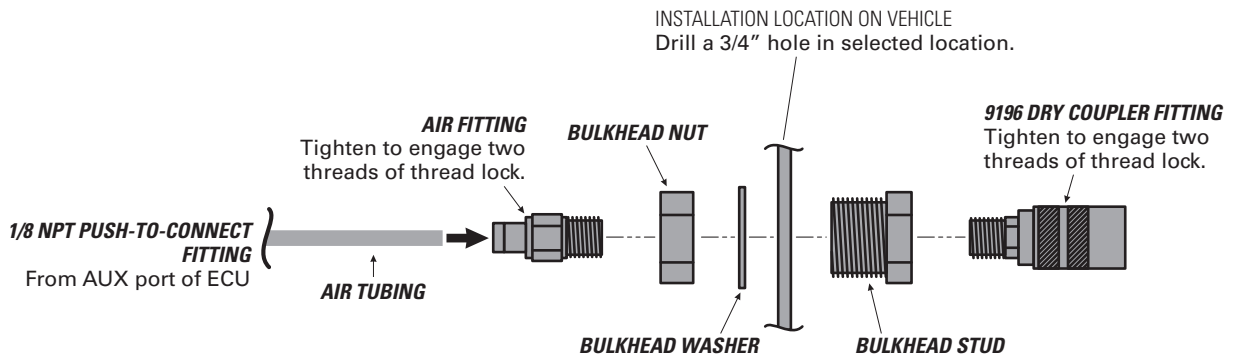

Connect the male Air Fittings to the dry couplers to use the inflation hose and inflator. When finished, simply disconnect and store in the supplied Firestone storage bag.

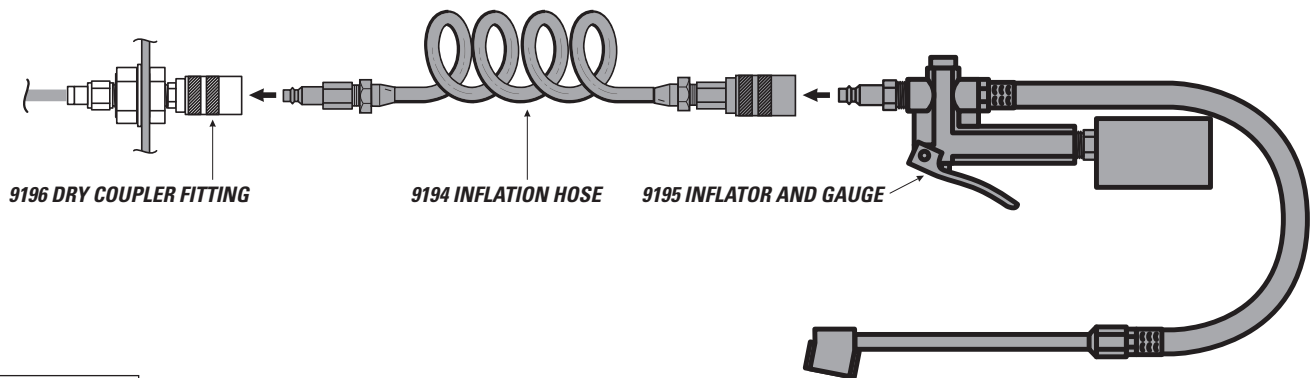

1 Clean up the installation using supplied NylonTies, and return all factory parts and materials to operative state.

USING SUPPLIED NYLON TIES, SECURE ALL WIRING AND AIR TUBING IN A MANNER THAT DOES NOT OBSTRUCT MOVING PARTS OR IN ANY WAY THAT AFFECTS YOUR ABILITY TO SAFELY OPERATE THE VEHICLE.



1 Download app from Google Play or Apple Store. Search for 'Air Command Dual'.

2 Start the vehicle and open app.

3 Select **SCAN** and click on the ECU from the screen.

4 Follow onscreen prompts to link to the ECU and press **NEXT**.

5 Default passkey is **123456**.

6 Select 'Settings' icon and turn on **TANK MODE**. This will maintain the tank pressure at the desired settings (On 90 psi - Off 120, for example).

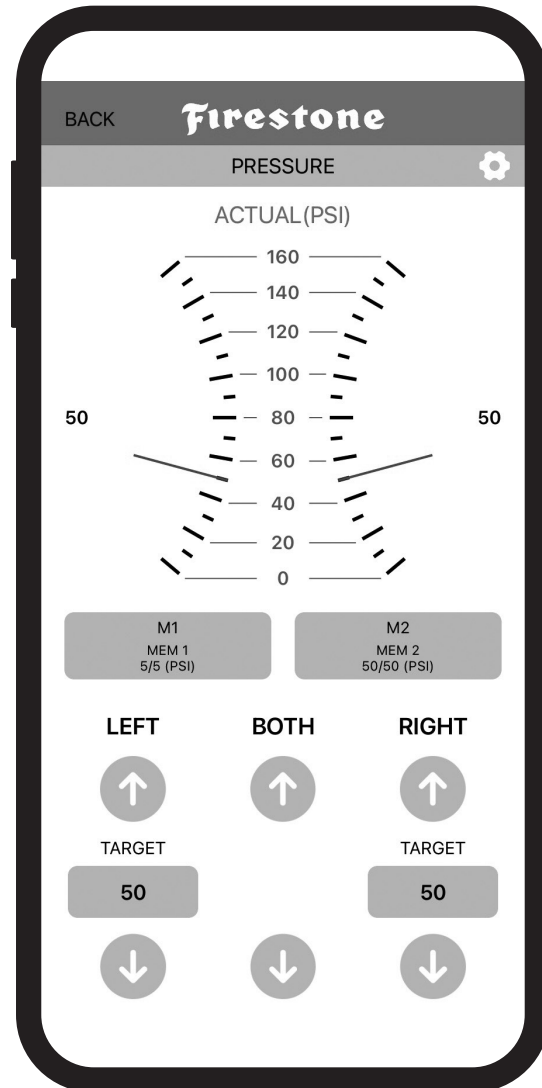

6 FACTORY RESET (TROUBLESHOOTING ONLY)

- Remove fuse from red wire by battery or remove wire harness connector from ECU
- Remove app from phone
- Reinstall fuse or plug wire harness connector back into the ECU
- Download the app

The ECU will remain active for two hours after initial installation or factory reset.

After voltage drop due to engine stop, the ECU will remain active for up to thirty minutes.

A SOLID GREEN LED
ON THE ECU INDICATES
BLUETOOTH IS CONNECTED

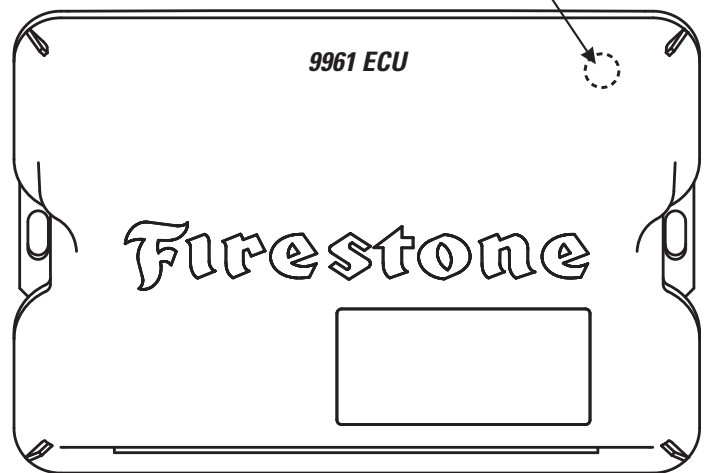

OVER THE AIR FIRMWARE UPDATE

If an OTA update is available, a popup will appear on the app to activate.

After voltage drop due to engine stop, the ECU will remain active for five minutes.

- If you select **SKIP**, the firmware can be updated once connected to the app
- If you select **INSTALL**, the firmware will begin to update. This will take approximately 3-4 minutes
- Keep the app open during the update and stay within range of the ECU until complete
- Once OTA is complete, restart the app, use the default passkey, and use as normal

1 Select **AUX PORT** in the app settings menu

2 **MANUAL MODE**
(slide from OFF to MANUAL)

- This will start the compressor and allow the user to monitor the air pressure that the auxiliary tubing is being used to fill.
- There is no timer using this setting

AUTO MODE

- Click **AUTO** and input a pressure
- Slide down to the AUTO setting to activate the system
- A timer will start to countdown and the system may cycle on/off as the external component is being filled

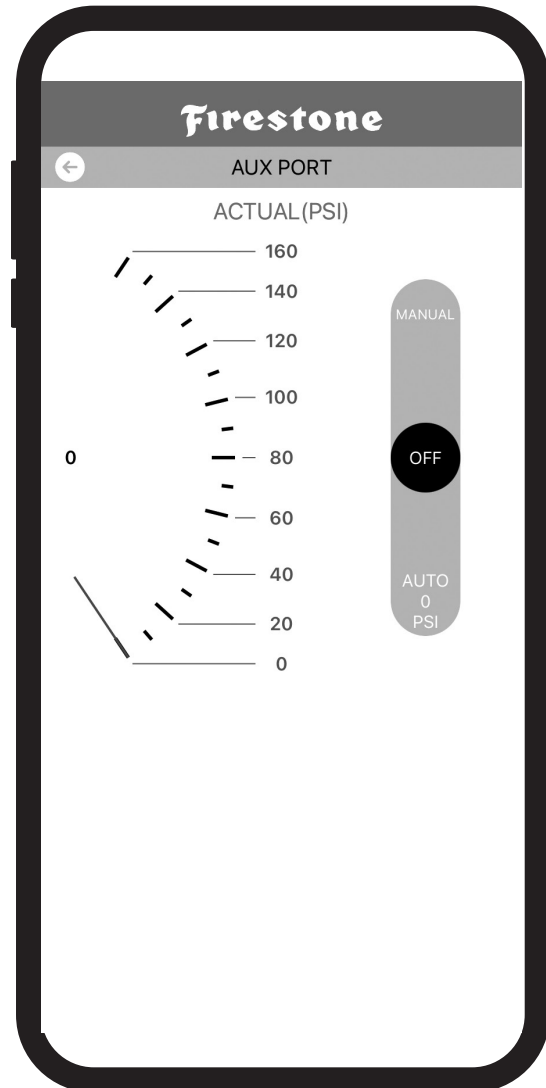



THE SYSTEM IS CONTROLLED BY THE USER TO FILL EXTERNAL ITEMS. IT IS THE RESPONSIBILITY OF THE USER TO INFLATE TO THE APPROPRIATE PRESSURE DETERMINED BY THE MANUFACTURER OF THE ITEM.

DO NOT EXCEED THE CAPACITY OF THE FIRESTONE COMPRESSOR FOR RUNTIME (DUTY CYCLE) OR PRESSURE

MAIN SCREEN

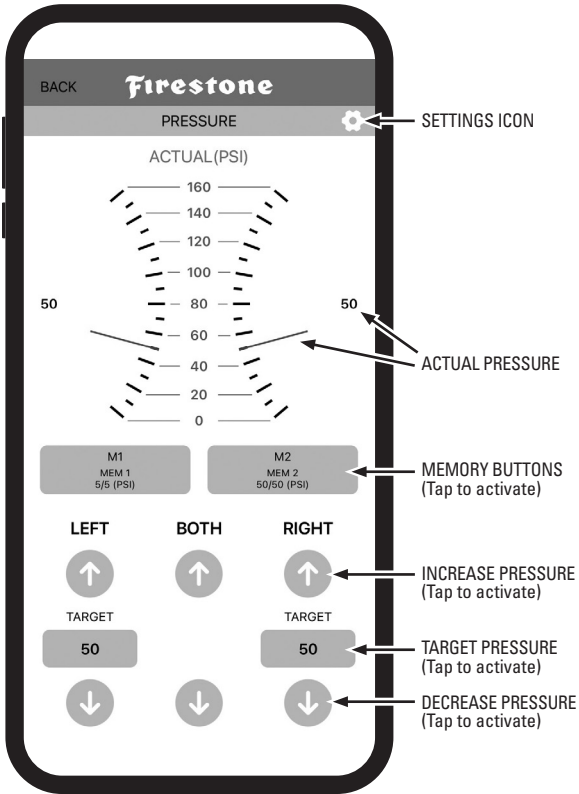

SETTINGS

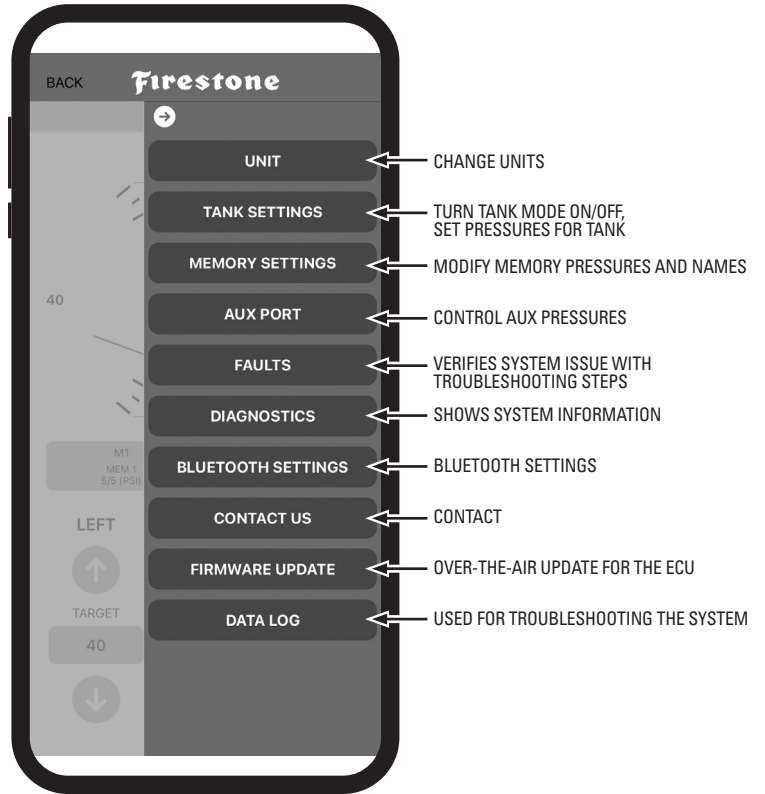

TANK SETTINGS

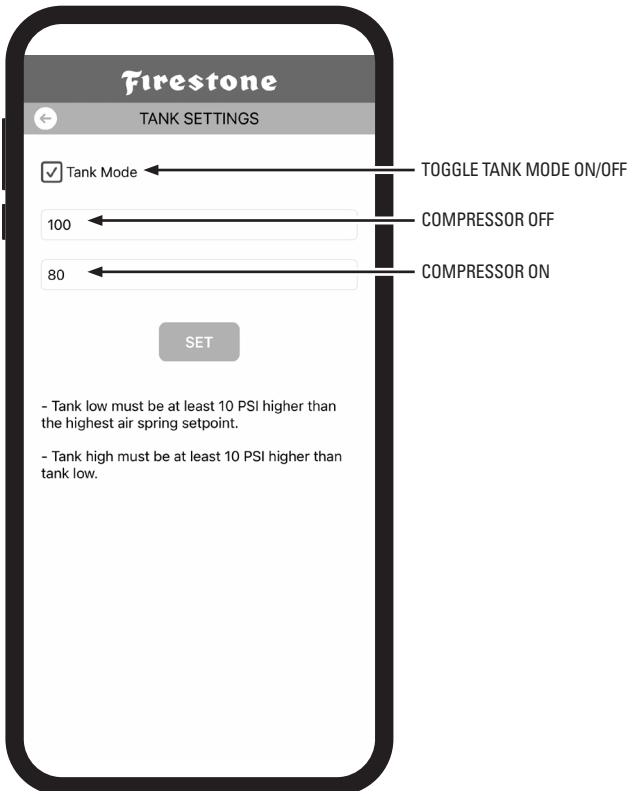

MEMORY SETTINGS

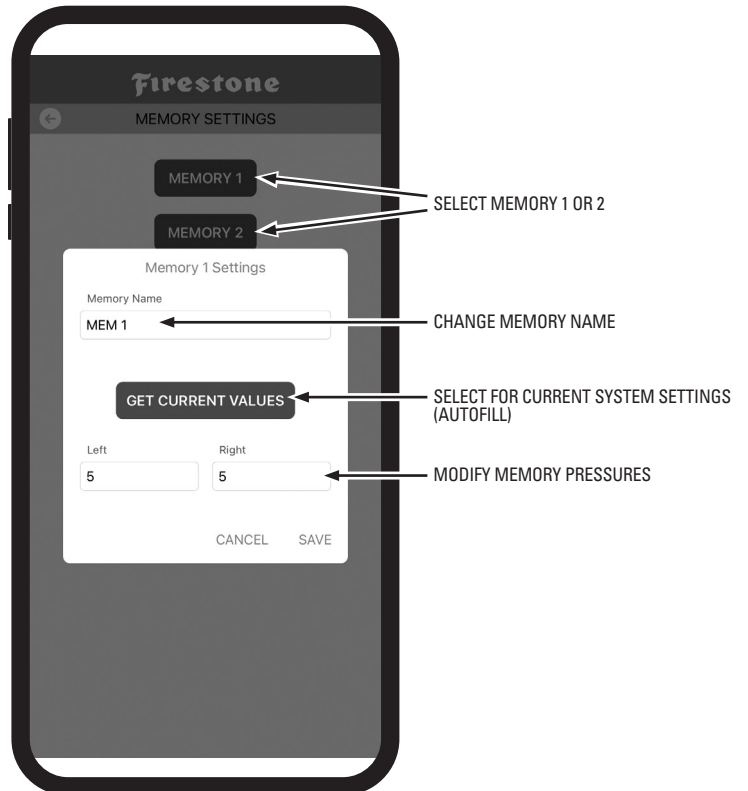

AUXILIARY

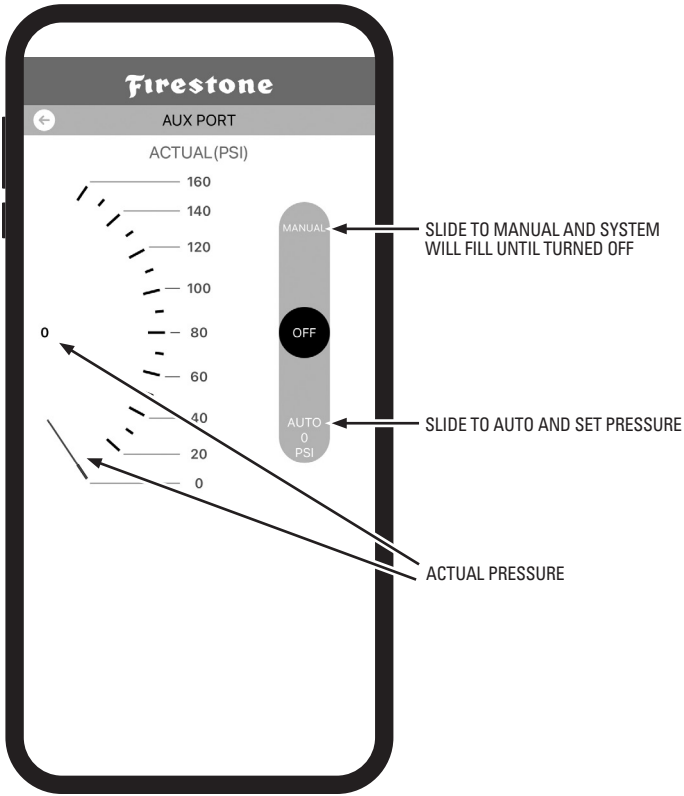

SYSTEM FAULT

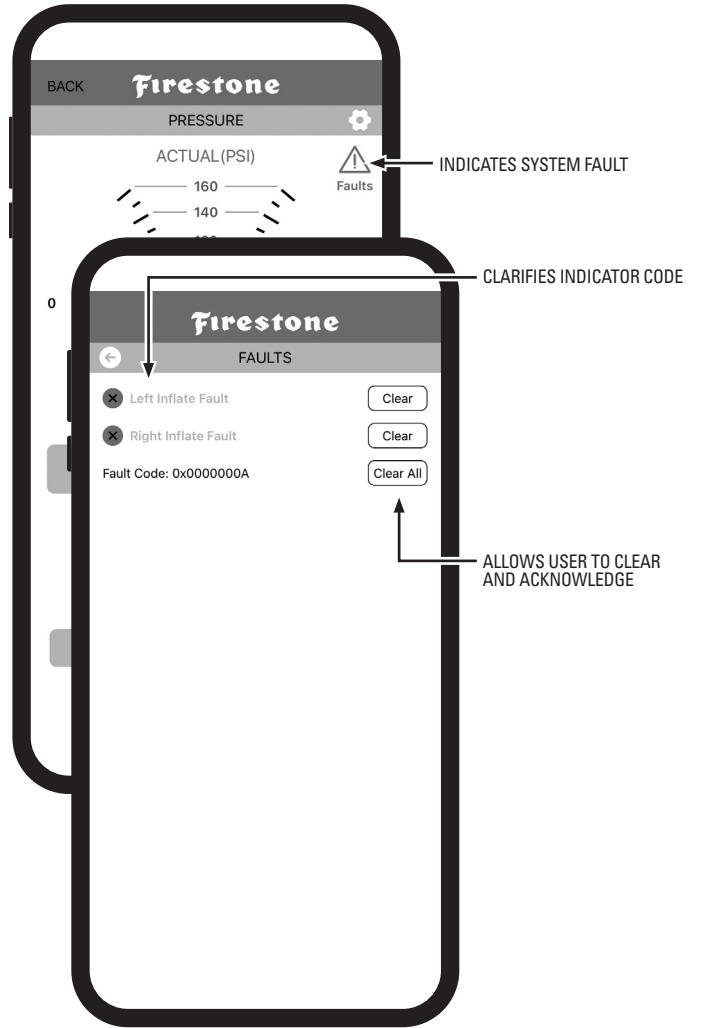

DIAGNOSTICS

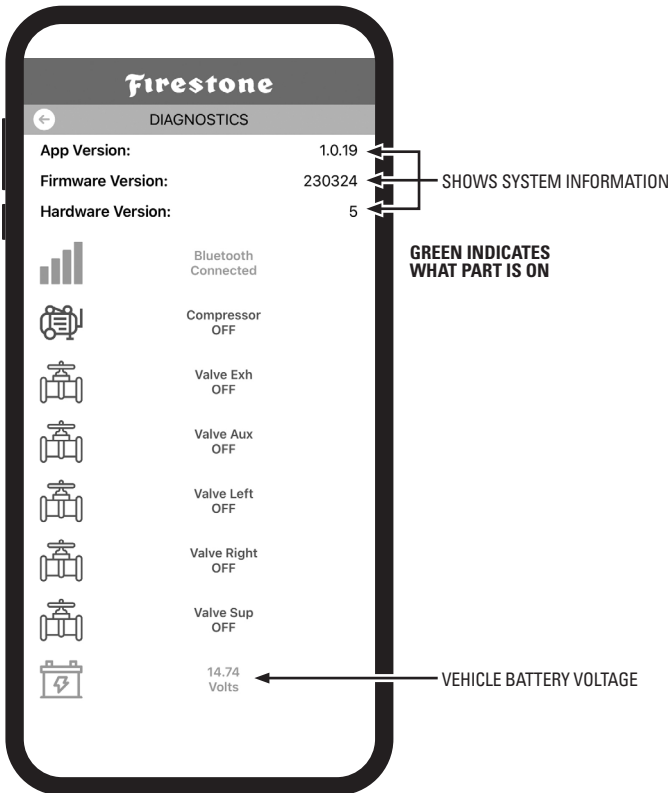

12

TEST THE SYSTEM

With the Air Command™ Dual App and your Air Springs installed, you are ready to test the system.

- 1** Reattach the negative battery cable.

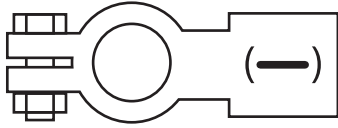

- 2** Turn on your vehicle's ignition.

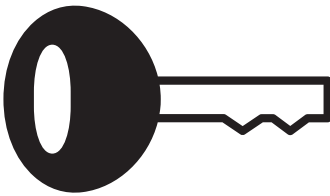

- 3** Use the Air Command™ Dual App to inflate the Air Springs to 70 PSI. See Step 9 for details.

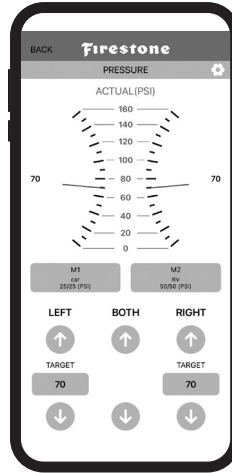

- 4** Spray fittings with soap and water mixture or glass cleaner.



- 5** Observe bubbles.

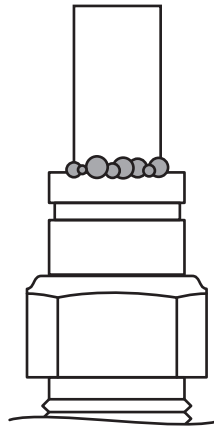

**SMALL SOAP BUBBLES
THAT DO NOT EXPAND**

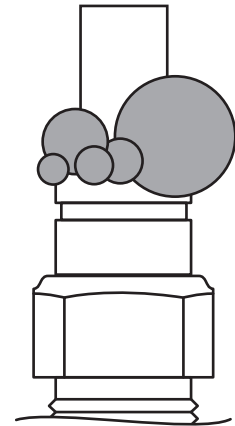

**SOAP BUBBLES
THAT EXPAND**



NO LEAKS?

Congratulations! You're riding right with the push of a button! Remember to review the Operating Instructions.

LEAK?

Bummer. Continue to Step 13 to fix the leak.



EXHAUST ALL AIR FROM THE SYSTEM PRIOR TO RELEASING AIR TUBING FROM AIR FITTINGS.



- 1 Use the Air Command™ Dual App to deflate the Air Springs to 5 PSI. See Step 9 for details.

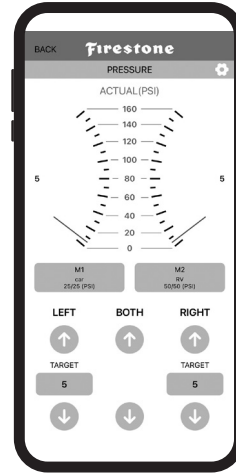

LEAK AT AIR TUBING AND AIR FITTING

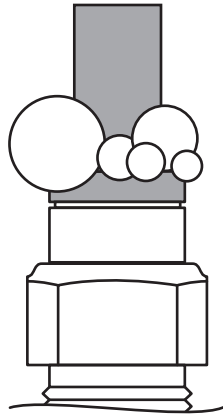

Release Air Tubing (see page 4).
Review proper cuts and procedures
in Step 5. Repeat Step 5.

LEAK AT BASE OF AIR FITTING

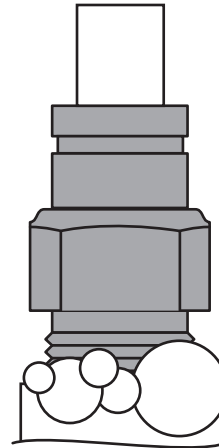

Tighten Air Fitting one turn
or until leak stops.

STILL HAVE A LEAK?

Refer to the Troubleshooting section of the Instruction Manual. If the leak persists, or if there is an issue with a leaking part, email us at rtech@fsip.com. If emailing, please include photos to help us better diagnose and understand any problems you may be experiencing.



AIRIDE

firestoneairide.com

BEFORE YOU DRIVE, CONFIRM THE FOLLOWING:

- Secure all AirTubing and wiring.
- The system passes the leak test and holds air.
- The Air Compressor ground ring terminal is contacting bare metal, and coated with silicone if possible.
- The Wire Harness is grounded to the negative (-) battery terminal. The ECU needs a good, clean, interference-free ground.
- There is a loop in the AirTubing as shown to prevent water or debris from getting into the Air Compressor head and damaging it.

Or, email us at rrtech@fsip.com. If emailing, please include photos to help us better diagnose and understand any problems you may be experiencing.

Firestone

Firestone Industrial Products

CONNECT WITH US



@firestoneip



FirestoneIP



Firestone Ride-Rite